

CITY AND COUNTY OF NEWCASTLE-UPON-TYNE.

REPORT

OF THE

MEDICAL OFFICER OF HEALTH

WITH

TABLES AND DIAGRAMS,

OF THE

SICKNESS AND MORTALITY,

SANITARY RETURNS, PLANS, FORMS, &c.,

FOR

THE YEAR 1882.

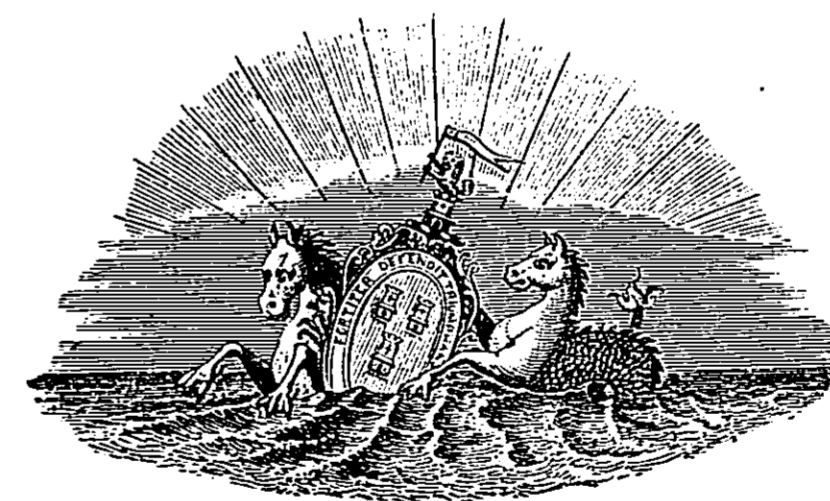

Newcastle-upon-Tyne:
ANDREW REID, PRINTING COURT BUILDINGS, AKENSIDE HILL.

1883.

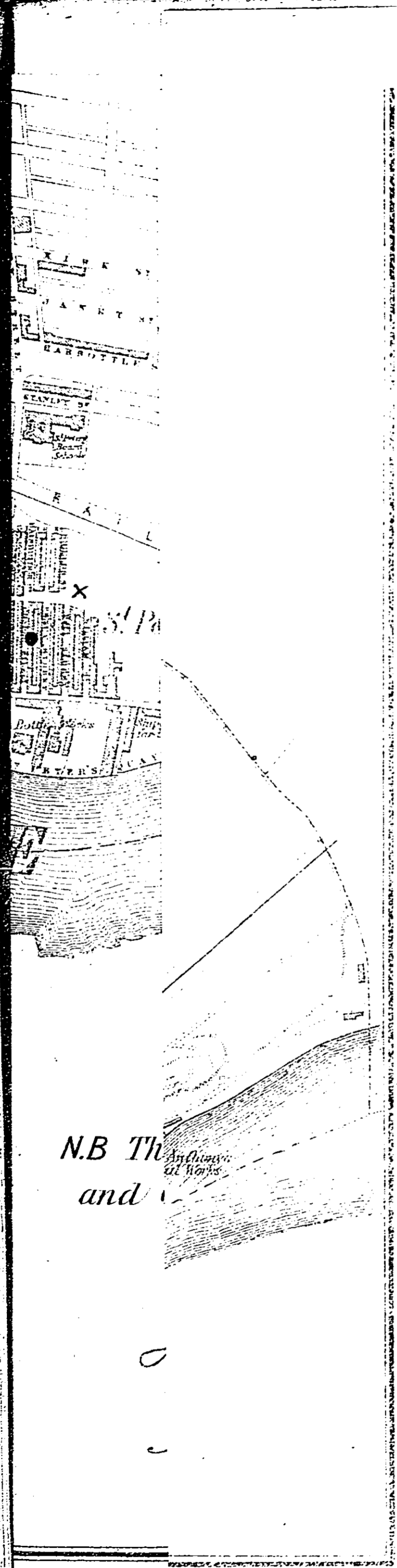

TO MR. ALD. THOMAS WILSON, J.P., CHAIRMAN OF THE SANITARY
COMMITTEE OF THE CORPORATION OF NEWCASTLE-UPON-TYNE.

SIR,—I have the honour to submit herewith my Annual Report
for 1882.

The year has been one of exceptional sanitary interest. The con-
current prevalence, during many months, of Typhus and Small-pox, to an
extent greater than has been assumed by either disease in any other
corresponding period of the past decade, has been a subject of serious
responsibility engaging the constant attention of the Committee and
yourself.

In coping with these and other zymotic outbreaks no efforts have
been wanting. Under the direction of the Sanitary Authority the
ordinary resources available for this purpose, viz.:—means of securing
information, isolation, and disinfection of cases of infectious disease, have
been extended and utilized to the full, and further important extensions
have been put in progress. Where the statutory provisions to these
ends have been, in the opinion of the Authority, inadequate, proper
action has been taken (and with a considerable degree of success) to
remedy the deficiency.

In conclusion allow me, Sir, to express to the Committee and yourself
my grateful acknowledgments for the courteous encouragement and help
I have received in the endeavour to perform my duty.

I am, Sir,

Your obedient Servant,

HENRY E. ARMSTRONG,

MEDICAL OFFICER OF HEALTH.

Health Department, Town Hall,
Newcastle-upon-Tyne,
2nd April, 1883.

TABLE OF CONTENTS.

	PAGE.
(A.)—STATISTICS—	
Rates of Births and Deaths in City and Sub-districts	5
Rates of Death in each of the past 15 years	5
Zymotic Diseases	6
Respiratory Diseases	7
Infant Mortality	8
Uncertified Deaths	9
Marriages	9
(B.)—ADVICE TENDERED AND ACTION TAKEN—	
(1.)—ZYMOTIC DISEASE—	
(a.)—Fever Hospital—Admissions	
Do. Occupation of Wards during the year	9
Do. Maintenance Charges	10
Do. Proportion of Cases isolated to those notified	11
Do. Inadequacy of accommodation... ..	11
Do. Nurses contracting Fever	12
Do. Additional accommodation provided for Small- pox	14
Do. New Sanitary Hospital	15
(b.)—Zymotic Disease in the City—	
<i>Small-pox</i> —History, Mortality, Origin, and Causes of Spread... ..	16
Do. In Byker, and near Old Small-pox Hospital	17
Do. Cases illustrating how Infection may be Spread	19
Do. Preventive Measures	21
Do. Observations—Vaccination, Compulsory Revaccina- tion by the Sanitary Authority	22
<i>Typhus</i> —History, Mortality, Cause of Spread, Preventive Measures	25
<i>Enteric Fever</i> —Do. do. do. do. do.	27
Do. And Privy Midden System in Byker	28
Do. How Infection may be Spread—Action taken	28
<i>Scarlet Fever</i> —History, Mortality, Cause of Spread, Defective Isolation	29
Do. Want of Hospital accommodation for... ..	30
Do. Cases illustrating how Infection may be Spread	30
<i>Diarrhœa</i> —Local Government Board Inquiry	31
(2.)—SANITARY DEFECTS OF HOUSE PROPERTY IN BLOCK—	
Windsor Terrace, Meldon Terrace, Jesmond High Terrace, Fenwick Terrace, Half Moon Yard, High and Low Folds, Percy Court, Leighton's Buildings, Cook's Buildings, Appleton's Buildings, Vint's Buildings	32-4
(3.)—SANITARY DEFECTS OF HOUSE PROPERTY NOT IN BLOCK—	
Prudhoe Street, St. Ann's Street, Sandgate	35
(4.)—REFUSE REMOVAL	36

	PAGE.
(5.)—INTERMENT OF CORPSES OF POOR PERSONS	36
(6.)—DAIRIES, COWSHEDS, AND SLAUGHTER HOUSES... ..	36
(7.)—PAVING, &c.	37
(8.)—GENERAL WORK OF SANITARY STAFF—	
Nuisance Removal, House-to-House Inspection, Disinfection, Fish In- spection	38
(9.)—UNWHOLESOME PROVISIONS—	
Further Legal Powers with regard to	39
(10.)—BUILDING PLANS	40
(11.)—SANITARY LEGISLATION—	
Notification of Infectious Disease	40
Compulsory Isolation in certain Cases	40
Maintenance in Hospital by Corporation in certain Cases	41
(12.)—WELL WATERS EXAMINED	41

APPENDICES.

A.—TABLES—

I.—Births and Deaths in City and Sub-districts	43
II.—Rates of Death in Newcastle and other large Towns compared	43
III.—Rates of Death in different Classes of Disease	44
IV.—Numbers of Deaths in different Classes and Orders of Disease	45
V.—Ages at Death	46
VI.—Weekly Mean Numbers of Deaths at Ætal Periods	46
VII.—Births and Deaths in different Quarters of Four Years	46
VIII. } Deaths of Children	47
IX. }	
X.—Uncertified Deaths	49
XI.—Deaths from Miasmatic Disease	50
XII.—Locality of Deaths from prevalent Zymotic Diseases	51
XIII.—Fever Hospital Returns	58
XIV. (A.)—Suspected and Unwholesome Food	58
XIV. (B.)—Return of Fish Received in Newcastle Fish Market	59
XV.—Infected Articles of Bedding, Apparel, &c., Destroyed or Disinfected	60
XVI. (A.)—Houses Disinfected	61
XVI. (B.)—Return of Cases of Infectious Disease Notified by Medical Prac- titioners	61
XVII.—Nuisance Removal	62
XVIII.—Magisterial Proceedings	63
XIX.—Rainfall, Mean Temperature, &c.	63
B.—Small-pox in relation to Vaccination (Hospital Returns).	64
C.—House Plans, showing sanitary defects.	
D.—Chart of Diseases liable to fluctuation.	
E.—Disease Map of Newcastle-upon-Tyne.	
F.—Map of Streets near Old Small-pox Wards.	
G.—Slaughter-house Inspection—Form.	
H.—House-to-house Inspection—Form.	

City and County of Newcastle-upon-Tyne.

REPORT, 1882.

(A.)—STATISTICS.

DURING the fifty-two weeks ended 30th December, 1882, 5,475 births and 3,403 deaths have been registered in the City. The births represent a rate of 37·0 and the deaths a rate of 23·0 per 1,000 of a population of 147,626 at all ages, as estimated by the Registrar General to the middle of the year.

The following is a Table of the recorded rates of mortality for previous years:—

RATES OF MORTALITY PER 1,000 POPULATION OF NEWCASTLE-UPON-TYNE.

A.D.	Rate per 1,000.
1868	27·1
1869	27·2
1870	25·4
1871	32·2
1872	26·3
1873	30·1
1874	29·2
1875	26·1
1876	22·7
1877	22·3
1878	23·7
1879	23·5
1880	22·3
1881	21·7
1882	23·0

A comparison of the rates of birth and death in the different registration Sub-districts of the City during 1882 and the previous year is subjoined:—

RATES OF BIRTH AND DEATH PER 1,000 POPULATION (ESTIMATED).

REGISTRATION SUB-DISTRICTS.	BIRTH-RATES.		DEATH-RATES.	
	1881.	1882.	1881.	1882.
Westgate*	37·6	37·1	21·8	21·2
St. Andrew's	29·0	26·5	18·0	18·6
St. Nicholas'†	29·7	27·5	41·5	44·5
All Saints'	39·5	39·2	22·2	22·9
Byker	38·9	44·6	17·1	22·4
City	36·6	37·0	21·7	23·0

* Workhouse. † Infirmary and Fever Hospital.

In connexion with this Table the increased rates of birth and death in the Sub-district of Byker, as compared with the corresponding rates of 1881, are to be noticed. The mean annual birth rate of Newcastle for five years immediately preceding 1882 is 38.6 per 1,000 population.

The condition of the different registration Sub-districts in regard of mortality from the Miasmatic order* of Zymotic diseases during last, as compared the preceding, year is as follows:—

SUB-DISTRICTS.	Number of Deaths from Miasmatic Diseases.	
	1881.	1882.
Westgate	206	210
St. Andrew's	30	39
St. Nicholas'	67	91
All Saints'	83	88
Byker	61	152
City	447	580

The mortality from the chief Zymotic diseases, viz.:—Small-pox, Measles, Scarlet Fever, Diphtheria, Whooping Cough, Fever (including Typhus, Enteric, and Simple Continued Fevers), and Diarrhœa, in the registration Sub-districts† during the successive seasons of the year is as follows:—

NUMBER OF DEATHS IN 1882.

	WESTGATE.‡				ST. ANDREW'S.				ST. NICHOLAS'.				ALL SAINTS'.				BYKER.								
	1st Qr.	2nd Qr.	3rd Qr.	4th Qr.	Total.	1st Qr.	2nd Qr.	3rd Qr.	4th Qr.	Total.	1st Qr.	2nd Qr.	3rd Qr.	4th Qr.	Total.	1st Qr.	2nd Qr.	3rd Qr.	4th Qr.	Total.					
Small-pox	4	14	18	...	1	7	8	...	2	3	5	...	4	4	...	2	15	5	22	...					
Measles...	1	1	2	...	1	1	3	...	4	2	...	1	4	...	7	...					
Scarlet Fever ...	6	8	8	30	...	1	5	...	1	7	2	...	4	5	...	4	4	5	10	23					
Diphtheria	1	1	2	1	...	1	1	...	1	1	1	1					
Whooping Cough	21	24	2	350	...	2	7	1	10	4	1	...	6	1	5	6	12	12	8	7	2	29			
Typhus...	1	1	2	...	1	3	4	...	1	1	2	10	14	...	1	2	7	10			
Enteric (or Typhoid) Fever	1	1	1	4	1	...	3	4	6	...	8	8	22	...			
Simple Contd. Fever	1	1			
Diarrhœa	9	6	57	7	79	...	2	10	...	12	1	2	9	2	14	2	1	19	3	25	1	1	23	4	29

* See Appendix A., Table XI.

† Corrected by distribution of those occurring in the Fever and Small-pox Hospitals to the district from which each patient came.

‡ Exclusive of Benwell and Fenham.

The rate of mortality in the City from the chief Zymotic diseases is 3.9 per 1,000 population as compared with rates of 3.0 and 3.3 in 1880 and 1881. The principal factors in this class are:—

<i>Small-pox</i> , from which a total of 57 deaths is recorded against 10 in 1881.				
<i>Scarlet Fever</i>	82	52
<i>Whooping Cough</i> ..	107	70
<i>Typhus</i>	30	20
<i>Enteric Fever</i>	30	38
<i>Diarrhœa</i>	159	149

DISEASES OF THE RESPIRATORY ORGANS.

Under this head 483 deaths are returned as against 474 in the year before. The two leading diseases of the Order—Bronchitis and Pneumonia—have together caused 396 deaths, as compared with 409 in the year 1881. The following Table shows the number of deaths from the two diseases combined in each Sub-district during the successive quarters of the year under report:—

DEATHS FROM BRONCHITIS AND PNEUMONIA.

A.D. 1882.	REGISTRATION SUB-DISTRICTS.					CITY.	Number in previous year (1881.)
	Westgate (Workhouse)	St. Andrew's	St. Nicholas' (Infirmary).	All Saints'.	Byker.		
1st Quarter ...	36	16	9	27	27	115	124
2nd " ...	46	15	7	26	25	119	99
3rd " ...	16	4	9	11	16	56	75
4th " ...	38	11	11	22	24	106	111
Year	136	46	36	86	92	396	409
Number in previous Year (1881) ...	160	50	37	85	77	409	...

Concerning the prevalence of the two chief Respiratory diseases in the different seasons of the year, it is to be noted that in the first quarter of 1882, which, compared with that of 1881, was dry and mild (total rainfall 2.83 inches, mean temperature 44.30° F., with a tolerably equable weekly mean), there was a slight decrease from these causes in the mortality of the entire City as compared with the returns of the first quarter of 1881, not participated in by the Sub-districts of All Saints' and Byker; in the second quarter, which, compared with that of 1881, was wet but about equally temperate (total rainfall 8.00 inches, mean temperature 50.90°, with a steadily rising weekly mean), there was a general increase in the City, St. Nicholas' Sub-district excepted, as compared with 1881; in the third quarter, which was drier and warmer than that of 1881 (rain-

fall 7.23 inches, mean temperature 57.20° F., with a weekly mean rising steadily to 62.60°, in the middle of August a gradually falling to 52.60° at the end of the quarter), there was a decrease of these deaths in the total returns of the City, but an increase in St. Nicholas' and Byker Sub-districts; in the fourth quarter, which, compared with that of 1881, was wet and rather colder (rainfall 10.49 inches, mean temperature 43.1° F., with a weekly mean ranging from 54.50° at the beginning of October to 30.60° in the middle of December), the mortality in the two quarters of the respective years was nearly equal throughout all of the districts.

INFANT MORTALITY.

The number of children dying before the completion of the first year of life is 914, as compared with 820, 927, and 784 respectively in 1881, 1880, and 1879:—

	No. 1. Deaths of Children under 1 year of age.		No. 2. Rates per cent. of Deaths under 1 year to Births registered.		No. 3. Death Rates of Children under 1 year of age per 1,000 esti- mated Population at all ages.	
	1882.	1881.	1882.	1881.	1882.	1881.
Westgate	360	346	15.5	14.9	5.8	5.6
St. Andrew's	86	81	17.0	14.9	4.5	4.3
St. Nicholas'	65	73	23.3	25.0	6.5	7.4
All Saints'	176	155	18.2	16.1	7.1	6.4
Byker	227	165	16.2	13.7	7.2	5.3
City	914	820	16.7	15.4	6.2	5.6

From this Table it appears that during 1882, as compared with the year before, there has been an actual increase, as well as increased rates to births and population in the mortality of infants, in all the registration Sub-districts except that of St. Nicholas'. The infant mortality of the year under report is a slight improvement on that of the year 1880.

The following are the most prominent factors of the infant mortality:—

	DEATHS.	
	A.D. 1882.	A.D. 1881.
Whooping Cough	35	23
Diarrhoea	93	83
Tabes Mesenterica	32	20
Convulsions	122	113
Bronchitis	75	79
Atrophy and Debility	225	197
Suffocation	25	8
TOTAL	607	518

UNCERTIFIED DEATHS.

That is to say, deaths registered without any proper medical certificate having been given or inquest held, have contributed 123 cases to the general mortality, as compared with 122 during the previous year (see Table X., Appendix A). About 74 per cent. of these are those of children under one year of age.

The proportions of infants and persons of other ages, whose deaths have not been properly attested, are singularly near to those of the previous year; thus, there were 91 uncertified deaths, under one year, in 1882, against 90 in 1881. The number aged one year, but under two years, was 6; and the number aged two years and upwards was 26 in each of these periods.

MARRIAGES.

During the year ended 31st March, 1882, the number of marriages registered in Newcastle-upon-Tyne* was only 1,428, against 1,717 in the previous twelve months, and 1,700 in the year before that.

The births in the same area during the calendar year 1882 were 5,676, against 5,539 in 1881, and 5,537 in 1880.

(B.)—ADVICE TENDERED AND ACTION TAKEN.

(1.)—ZYMOTIC DISEASE.

(a.)—FEVER HOSPITAL.

During the year 371 patients have been admitted to the Fever and Small-pox Hospitals, including 241 cases of Small-pox,† 98 of Typhus, 18 of Enteric, 2 of Scarlet Fever, and various cases of other diseases (see Appendix A, Table XIII.)

The monthly admissions ranged from 1 (Typhus) in January and 1 (Enteric Fever) in April to 78 (51 Small-pox, 26 Typhus, and 1 Enteric Fever) in November. 101 of the cases of Small-pox were admitted in September and October; and 61 of the Typhus cases in November and December.

The Hospital at Bath Lane was empty on one day only (February 7th).

The Table on the following page shows the highest and lowest daily number of patients under treatment during each month of the year.

* Superintendent Registrar's District, which includes the Municipal area and the Townships of Benwell and Fenham.

† The state of these in regard to vaccination is shown at page 22, and also in Appendix B, page 64.

FEVER AND SMALL-POX HOSPITALS, NEWCASTLE-ON-TYNE.

HIGHEST AND LOWEST DAILY NUMBER OF PATIENTS UNDER TREATMENT.				
A.D. 1882.	Lowest Number.	Highest Number.	Monthly Average.	Remarks.
Jan.	2	9	5.5	Bath Lane Hospital only.
Feb.	0 (1 day)	6	2.3	Do. do.
Mar.	5	10	8.0	Do. do.
April	1 (1 day)	9	5.8	Do. do.
May	1	5	2.6	Do. do.
June	2	7	4.5	Do. do.
July	6	29	15.0	Do. do.
Aug.	25	38	29.6	Byker Small-pox Convalescent Home opened on 16th August.
Sept.	33 (2 days)	52	44.3	
Oct.	43	70	61.6	Highest number includes 38 at Bath Lane and 32 at Byker.
Nov.	48	75	59.4	Highest number includes 48 at Bath Lane and 27 at Byker.
Dec.	47	58	52.4	Moor Small-pox Hospital opened 9th Dec. The highest number includes 33 at Bath Lane and 25 at Byker.

This Table shows, among other things, that averages of the number of beds occupied are no guide to the amount of accommodation required in a Hospital for infectious diseases.

The average daily number of patients in Hospital throughout the year was under 20, but during the last five months of the year there were never less than 25 in the Institution, and in November the admissions reached to 75. To meet such a number on emergency, it is obviously necessary that there must be a great many beds ready for use, but not to be occupied except during a small portion of the year. The total number of patients for whom beds to this extent were required last year was 371, less than half the admissions of the year 1871. This may be taken as an indication of the number which may again have to be provided for.

To secure early isolation of cases of infectious disease in Hospital, all available means have been adopted, including urgent persuasion by the Officers of the Health Department in the case of patients not under private treatment; the admission of patients gratis, or on easy terms; the reception of mothers with their infants, &c.

The maintenance of patients admitted was charged as follows:—

To the Sanitary Authority	205 cases.
„ Poor Law Authority	89 „
„ Private Guarantors	42 „
„ „ and Sanitary Authority jointly*	31 „
„ Public Institutions	4 „
Total	<u>371</u> „

* The persons in charge of the sick declaring themselves unable to pay the full amount (2s. per day) but willing to contribute towards it.

The measure of success which has attended the efforts of the Health Department to secure isolation is shown by the returns of the fourth quarter of the year, during which the provisions for the notification of infectious cases were in full operation. In that period, 129 of a total of 229 cases of Small-pox notified, and 79 of a total of 99 cases of Typhus, were admitted to Hospital. The patients have included, among others, many persons engaged in business establishments, hotels, schools, &c. The proportion of admissions from these classes, as compared with those in humbler circumstances, is considerably increased since the opening of the new Small-pox Hospital on the Town Moor, where the accommodation is good and the situation unexceptionable; which may be taken as an indication that the tendency to make use of a Hospital is, to a considerable extent, subject to the character, surroundings, and even the appearance of the building.

In more ways than one the Hospital has been found unequal to the requirements during the year. Thus, in April, the Sanitary Committee were informed that Scarlet Fever, Enteric Fever, and Typhus were under treatment in the Institution at the same time, at the risk of convalescents from one disease contracting another. Two patients (one in June and the other in September) caught Small-pox in Hospital—one of these sickened of the disease after discharge from the Institution. The case itself was very mild, but the patient's brother contracted the disease in a severe form and narrowly escaped with life. After the commencement of the Small-pox epidemic, the revaccination of the Fever patients in the Institution was considered necessary, and was done regularly by the public vaccinator, Mr. Hawthorn. The operation being found after some trial not to be always successful when done in the acute stage of Fever, it was deferred until convalescence. In the case of the patient attacked with Small-pox in June, revaccination had not, for some reason, been performed. In the other case the operation was done, but too late to be protective, the Fever convalescent having a very slight but unmistakable eruption of Small-pox about a week after the date of revaccination.

Shortly before the reopening of the Small-pox Convalescent Home the admission of a case of Small-pox was refused, owing to want of space; and on other occasions, after the Convalescent Home was in use, the admission of Small-pox patients to the Hospital was delayed until the vacation of beds allowed them to be taken in. Owing to pressure of this kind it was frequently necessary to remove patients to the Convalescent Home at an earlier stage than was desirable.

In other ways the accommodation has proved insufficient. Scarlet Fever, as has been shown in former Reports, is not regularly received

into the Hospital for treatment, there being no proper wards for that disease, as for other Fevers or Small-pox. Still cases occasionally demand admission, and whenever they can be put up with any degree of safety they are taken in. Thus, among other examples, the authorities of the Children's Hospital required the removal of a case from their institution at a time when the danger of infection, both to and from the patient, if removed to the Fever Hospital, was great. As attempts to find accommodation for the patient *outside the Fever Hospital* were unsuccessful, the case was, with reluctance, admitted. On one occasion admission was of necessity denied to a case of Scarlet Fever at the Barracks, and, on another, to a child whose mother had been recently confined. With the exception of such cases as the foregoing, Scarlet Fever—notoriously the most prevalent of all infectious diseases—is not provided for in Hospital.

Owing to the occupation of the wards by Typhus, the admission of patients suffering from Enteric Fever, except under great emergency, was declined during several months of the year. Many of these were in consequence nursed at their own homes at the expense of the Sanitary Authority.

The Typhus wards—always overstocked with beds, as has frequently been shown—were greatly overcrowded during much of the year. The result of this, and the evils of structure, on the patients, though undoubtedly serious, cannot well be demonstrated; but in the case of the nurses the effect is only too evident. During the year the number of nurses attending, for longer or shorter periods, on Typhus patients was fourteen, of which four were engaged temporarily and took duty a few days only. Of these nine contracted Typhus, and two died. Of the nine nurses attacked, all, except one, sickened within a very few weeks after first exposure to infection, as the following Table shows:—

FEVER HOSPITAL, NEWCASTLE-UPON-TYNE.

NURSES CONTRACTING TYPHUS IN DISCHARGE OF DUTY.			
	Date of Entering on Duty in Fever Wards.	Date of Sickening with Typhus.	Result of Illness.
C. J.	A.D. 1881, 27th Oct.*	A.D. 1882, 24th July	Recovery.
D. D.	1882, 11th "	" 1st Nov.	"
C. P.	" 31st Aug.	" 25th Oct.	"
M. J. T.	" 7th Nov.	" 22nd Nov.	"
S. G.	" 12th Sept.	" 23rd "	"
J. S.	" 20th Nov.	" 16th Dec.	Death.
J. H.	" 3rd Dec.	" 19th "	Recovery.
E. A. E. E.	" 13th "	1883, 9th Jan.	"
C. R.	" 3rd "	" 10th Jan.	Death.

* The first case of Typhus, of the epidemic of the year under report, was admitted on June 24th. The nurse had been on duty during the outbreak of the previous year.

Contrasting favourably with the above returns in the Typhus wards are those of the adjacent Small-pox block, in which nine different nurses were engaged for longer or shorter terms during the year, all except one (who had had Small-pox) being revaccinated immediately before taking duty. None caught Small-pox. One of these Small-pox nurses was afterwards transferred to the Typhus wards and caught Fever.

Lest it should be thought that the foregoing results are to be accounted for by the more infectious character of Typhus as compared with Small-pox, it should be stated that no Small-pox patients or persons other than nurses in the Hospital contracted Typhus, whereas two Fever patients (as already shown) caught Small-pox.

The following is an extract from one of the Fortnightly Reports of the Medical Officer of Health, relating to the nurses struck down by Fever:—

"There is great difficulty in filling the places of those thus disabled. Any one appointed to a vacancy is taken on duty with the almost certainty that in a week or two she will herself become a patient, and her place be taken by another. The knowledge of this is exceedingly depressing to the nurses themselves, and unfits them for their dangerous duty. The experience of the present epidemic and its effect on the hospital staff is no new thing, and it will be repeated as often as large numbers of cases of Typhus are gathered together in the narrow limits of the existing Fever House.

"The sickening of nurses is, as has frequently been shown, directly attributable to the structural defects of the building, which are such as no words can too strongly condemn. Owing to want of sufficient rooms, nurses of good class on taking ill have had to be put in the same wards as the ordinary patients, many of whom are paupers. The wards themselves have for months been in an almost constant state of overcrowding, which is believed to have had an injurious effect upon the patients."

The want of accommodation for private patients has been felt several times during the year, as has also been the case with probation wards for doubtful cases of disease. This unfulfilled requirement involves a special responsibility in the medical management of a Fever Hospital. It is a common thing for medical men to require the removal to Hospital of suspected or undeveloped cases of infectious disease. Cases are also frequently sent to Hospital on a misconception as to their real nature. Thus last year a domestic servant admitted from a private house, on certificate that she was suffering from Typhus, was placed among Typhus patients; but being found to be suffering from Enteric Fever was, with the effect of further crowding the Typhus wards already overfilled, provided with a separate room. Her retention in Hospital at the time was a matter of risk to herself. Again, Chicken-pox was sent to Hospital under diagnosis as Small-pox. A patient suffering from Syphilis was twice in three weeks

certified and sent to Hospital as a case of Small-pox. These are only instances of frequently recurring illustrations of the need of having accommodation for cases other than those of pronounced and unmistakable character.

The consent of relatives to removal of a patient to Hospital very often hinges on the question of the pecuniary terms on which he is to be admitted. The number of cases maintained at the expense of the Sanitary Committee shows that the subject has been dealt with in a liberal spirit. The existing arrangement grants free admission to persons not paupers, whose friends are clearly unable to pay for their maintenance. But many artisans and others living in tenement houses, who, by a little economy, might perhaps afford to pay the required charge, object, perhaps not unnaturally, to incur the expense when the isolation of the patient is primarily and principally for the public benefit.

The following case reported to the Committee in November is illustrative of some of the difficulties experienced. At No. —, — Street, one of the children of an employé at a theatre was found to be suffering from Small-pox:—

“The family, consisting of five persons, occupied one room. The father, though earning 35s. per week, declared himself unable to afford more than 3s. per week for his child's maintenance in Hospital. As the remaining of the patient at home would have been at the risk of spreading infection to the theatre, it was thought desirable to remove him on guarantee for this small sum. A few days afterwards a second case occurred in the family, which was removed without guarantee. As in the foregoing, it frequently occurs that relations agree to the removal of a patient to Hospital, but appear unable or unwilling to pay expenses, even though in receipt of fair wages. In the public interest it is desirable that such objections should not be allowed to act against the immediate removal of any case of infectious disease. This is only to be secured by free admission to the general wards.”

The Small-pox epidemic has throughout occupied the serious attention of the Sanitary Authority. Some account of the action taken will be found in a subsequent part of this Report. For the present it is proposed to show only what has been done in the matter of Hospital accommodation.

In summer a temporary nurse's sleeping room was added to the Small-pox block at Bath Lane. The Small-pox Convalescent Home at Byker was repaired and opened on August 14th. Shortly afterwards a wooden block of two wards (five beds each) was erected in the grounds of the Home. The original Home contains male and female day-rooms and five bed-rooms, besides the administrative department. The Institution has now accommodation for about 24 patients; more than this

number have, however, been in it on several occasions at the same time. 215 Small-pox convalescents were removed to the Home by the end of the year.

During summer the Small-pox block at Bath Lane Hospital became a source of apprehension to the Sanitary Committee. The results of treatment were unsatisfactory, several cases being complicated with Erysipelas and other allied forms of disease. Added to this there was a suspicious prevalence of Small-pox in Stowell Street and the densely populated locality adjoining the Hospital premises.

Owing to these circumstances the Committee determined to erect a new temporary Small-pox Hospital, of wood, on the Town Moor, in an open airy situation, remote from dwellings, and to close the Small-pox wards at Bath Lane. This was done with as little delay as possible. The new Hospital was opened to patients on December 9th, and has since been kept in full operation. It consists of administration, and two comfortable wards, for male and female patients, of twelve beds each, allowing about 1,700 cubic feet per bed. The wards are cheerful, well lighted, and airy. During the very cold weather difficulty was experienced in maintaining the wards at a proper temperature, but in other respects the hospital has been satisfactory as a temporary structure.

The number of cases admitted to the Moor Small-pox Hospital by the end of the year under report does not in regard of results afford sufficient basis for comparison with that of those treated in the old building at Bath Lane; but so far as they go, the returns of this Hospital are satisfactory. Of a total of twenty patients admitted to the Moor Hospital only one (an unvaccinated child) died, as compared with a Small-pox mortality of 16 per cent. (vaccinated and unvaccinated) at Bath Lane Hospital.

The question of a new Sanitary Hospital for Newcastle has been before the City Council at eight different meetings during the year, and has been fully discussed. In last Annual Report it was stated that a memorial against the Moor Lodge site had been presented in December, 1881. This opposition was supplemented in January by a letter from the War Authorities, objecting to the erection of a Hospital for infectious diseases in the neighbourhood of the Barracks. After continued monthly consideration until June, when a second deputation of owners of property at Spital Tongues attended to oppose the adoption of the Moor Lodge Site, it was abandoned in July. The question of the cost of erecting a suitable Hospital on other sites was referred to the Sanitary Committee. After the close of the year under report the Council resolved to devote ten acres of the Walker Estate, the property of the Corporation, and situated at Heaton, to the purpose of a Sanitary Hospital.

(b.)—ZYMOTIC DISEASE IN THE CITY.

SMALL-POX.

409 cases of Small-pox, including 59 deaths registered, have come under the notice of the Department during the year. Of these cases 229 have been notified by medical practitioners subsequent to the 28th of September. (See Appendix A, Table XVI. B.)

History of the Outbreak.—The incidence of Small-pox during the successive months of the year, on the different parishes or townships, as indicated by the number of cases coming to the knowledge of the Department* is shown by the subjoined Table:—

SMALL-POX IN NEWCASTLE-UPON-TYNE.

NUMBER OF CASES KNOWN TO THE HEALTH DEPARTMENT.									
A.D. 1882.	Elswick.	Westgate.	St. Andrew's.	St. John's.	St. Nicholas.	All Saints.	Jesmond.	Byker.	TOTAL.
January
February	1	1
March	1	1
April
May	1	2	3
June	...	1	1	5	7
July	...	1	1	1	...	27	30
August	...	1	8	1	7	4	1	28	50
September	...	4	24	7	13	4	8	20	80
October	...	11	35	3	6	1	19	1	82
November	...	18	28	11	6	5	7	12	88
December	...	13	24	6	7	2	4	10	67
Total	...	49	121	28	39	17	4	110	409

The general mortality of Small-pox to cases for the last quarter of the year, calculated roughly on the cases coming under notice and the deaths registered during the same period, is 13·9 per cent. The mortality of Small-pox in Hospital for the same period is 17·0 per cent. (For further details as to mortality see p.p. 22 and 64). These calculations require correction, from the circumstance that the death-returns include deaths of cases of sickness occurring before the beginning of the quarter, and hence not notified or counted in the Hospital admissions for the quarter; whilst the notifications and admissions to Hospital during the quarter include some whose deaths will not be registered until afterwards. 241, or about 60 per cent. of the cases known, were voluntarily removed to Hospital.

* The first notification of infectious disease under the Newcastle Improvement Act, 1882, was dated September 29th.

Origin and Cause of Spread.—Disregarding the isolated case in All Saints* in February, and that in Westgate in March, from neither of which infection is known to have spread, the outbreak began in Byker in May in a family who had immediately before come from Gateshead, in order, as they stated, to avoid infection, the disease being prevalent near the house in which they had lived. From this centre in Byker it spread. By reference to the Map (see Appendix E), which shows the extent of the disease as known to the Department, it may be seen that although more or less prevalent throughout Newcastle during the year, Small-pox has had certain areas in which it has flourished more than elsewhere. The most striking of these is that of the group of long streets to the south of Shields Road, Byker, in which there occurred 77 of the total of 409 cases in the City. As is well known, these streets consist for the most part of tenemented houses. Amongst the occupants of such houses there is great facility for the spread of disease by immediate contagion, both between different members of the same family and between the families in different tenements. In the area in question this cause was undoubtedly prominent. Of the 77 known cases in the area, 1 occurred in Clifford Street, 11 in Corbridge Street, 13 in Parker Street, 24 in Conyer's Road, 22 in Shipley Street, and 6 in Norfolk Road. In numerous instances the direct spread of infection by intercommunication from house to house was distinctly traced. The removal to Hospital of 41 of the cases only, or about 53 per cent. of those in the area, was secured by persuasion and other means short of compulsion. Ample means of keeping up infection was therefore left in the locality, and hence it is not surprising that Small-pox maintained its hold there throughout the year.

Another area in which the prevalence of Small-pox has been marked is that in and near Stowell Street, which, from its proximity to the Fever and old Small-pox Hospitals at Bath Lane, has a peculiar significance. On this account, and because of the attention which has recently been directed to the subject of the spread of infection from Small-pox Hospitals in the Metropolis, some detailed notice of the circumstances is desirable.

The first of the cases came under notice at No. 50, Stowell Street, on 20th August; this was five days after the opening of the Byker Convalescent Home, which had been necessitated by the number of patients in the Small-pox Hospital at Bath Lane. By the end of the month

* It appears that this case, although the first coming to the knowledge of the Department at the time, was not the first in the family, a prior case having occurred in January.

single cases were reported at Nos. 46, 18, and 34, Stowell Street, and 2 at No. 19, Stowell Square; in September 8th, other cases in Stowell Square (5 at No. 19, 2 at No. 2, and 1 at No. 20), and 5 in Stowell Street (1 each at Nos. 50, 46, 30, 24, and 13½) were reported; in October there were 1 fresh case in Stowell Square (No. 19) and 3 in Stowell Street (Nos. 54, 34, and 22), and in November 1 in the Street (No. 34) and 1 in the Square (No. 19); in December, 1 in the Street (No. 14) and 1 in the West Walls, near the gate of the Hospital. After December 9th no fresh cases of Small-pox were admitted to the Hospital at Bath Lane.

A plan is given (see Appendix F) showing the exact locality of the above cases, and their position in relation to the Small-pox wards of the Hospital, from which it will be seen that of 15 cases of Small-pox in Stowell Street during the year, 14 occurred on the side of the street next the Hospital. The house in which the first of these was reported (No. 50) is 55 feet distant from the block at that time occupied by Small-pox patients, and 40 feet from the Hospital Dead-house. The house, No. 19, Stowell Square, in which there were 9 cases of Small-pox, is 165 feet from the old Small-pox block, but directly opposite to it. The spread of infection from the first case in this house to other persons in the Square is attributable to the character and arrangement of the houses themselves rather than to proximity of the Hospital, the house No. 19 consisting of four single-room tenements, all of which open into a common passage, and each of which was invaded by the disease. The ventilation of the Square is also such as to facilitate the spread of contagium.

On the Disease Map for the City, appended to this Report, circles of an eighth of a mile, a quarter of a mile, and half a mile radius respectively are drawn round the old Small-pox block as a centre. The circle of half a mile radius is thus divided into three portions—innermost, middle, and outer. In the innermost portion (area, 152,053 square yards) there were 42 known cases of Small-pox; in the middle portion (area, 456,160 square yards) there were 57 known cases; and in the outer portion (area, 1,824,170 square yards) there were 95 known cases. The areas of the three portions, therefore, proceeding from within outwards are respectively in the ratio of about 1, 3, and 12, and their known cases of Small-pox in the ratio of 3, 4, and 6. As the populations of the three portions cannot be accurately determined, no calculation as to cases of Small-pox per cent. of persons living can be made.

In connection with the foregoing experience it is to be observed that on no previous occasion has the spread of Small-pox in Stowell Street been known to be so strikingly associated with the presence of cases in

the wards. The Small-pox block at Bath Lane was opened in 1871, and during the epidemic of 1871-2 was constantly occupied, and for many months was filled by acute cases, without causing, so far as is known, a single case of Small-pox among the surrounding population. There were cases of the disease in Stowell Square during the year 1881, but these were traced to contagium from others in Newgate Street (see Annual Report for 1881, page 64).

There has been no spread among the population dwelling near the Small-pox Convalescent Home at Byker Village.

Among the instances of the disease in private families, illustrating *how infection may be spread*, the most noteworthy under observation are the following:—

(a.)—In June, three cases, two of which were severe, in the family of P. B., consisting of nine persons, occupying two small rooms at No. —, Conyer's Road. The mother would not consent to the removal of her children to Hospital. The healthy members of the family passed into and out of the sick room, which opens directly into the kitchen. The yard at the back is common to this and another tenement.

(b.)—In a cellar kitchen at No. —, Blandford Street, from which a case was removed in June, the Medical Officer of Health found four dozen *bouquets of artificial flowers* made by the father of the patient, for sale on the street. They were destroyed by order, and the owner was compensated by the Sanitary Committee.

(c.)—In September a case of Small-pox came under notice in the family of a *dressmaker* at No. —, — Street. The family of nine persons occupied three rooms on the same flat, in one of which dressmaking was done. The dressmaker voluntarily suspended her business during the period of infection, and the dressmaking materials and other articles were purified in the disinfecting apparatus.

(d.)—In September two cases of Small-pox were removed to Hospital from *public-houses*, and in December one case at a public-house remained at home under private medical treatment.

(e.)—In October a case under private treatment was reported in the person of a *dairyman* at No. —, — Street. The patient with his wife and seven other persons occupied two rooms. The patient declined to be removed to Hospital, but volunteered to cause the dairy business, which was carried on at some distance from the house, to be kept separate from the infected premises. The Inspector, under the Dairies' Order, was as usual charged to see, as far as possible, that the undertaking was fulfilled.

(f.)—In November, W. S., a professional *waiter*, residing at No. —, — Street, was found to be suffering from Small-pox. His wife, who is a *laundress*, had for several weeks up to the 31st October received clothes to wash from Mrs. L., B— Street, where there had recently been two deaths from Small-pox. Mrs. S. stated that she asked Mrs. L. and the nurse who attended the patients if the cases were infectious, and they both replied in the negative. She further said that the clothes had a bad smell, and blamed them for carrying infection. In connection with this case it should be noted that the daughter of the S.'s was admitted to Hospital suffering from Small-pox on September 9th, and was discharged from Byker Convalescent Home, after due disinfection of person and clothing, on October 26th. The father took ill on the 4th inst.; Mrs. S. herself felt poorly on the 2nd inst., and had a slight attack of Small-pox. Of the fatal cases of Small-pox at No. —, B— Street, one occurred on the 11th October, after four days' illness, and the other on the 24th, after eight days' illness. A third case was removed to Hospital on the 1st November. The period of commencement of Mr. and Mrs. S.'s illness makes it probable that they did not contract infection from their daughter either before her removal to, or after her discharge from, Hospital.

(g.)—In the same month a fatal case of Small-pox occurred at No.—, — Street, in the house of the keeper of a *public mangle*. During the period of infection the mangling was discontinued by order, and compensation was given by the Sanitary Committee.

Among the causes of spread of Small-pox is to be noted the *neglect of vaccination*. This is shown by the fact that, of 241 Small-pox patients admitted to Hospital during the year, 60 (or nearly one-fourth) were unvaccinated, 2 were doubtful as to their vaccination, and 19 reported themselves as having been vaccinated, but had no vaccination marks; *i.e.*, 81 cases (or one-third of the whole) were practically unvaccinated.

This neglect was found to be paralleled by the carelessness or dilatoriness of the healthy members of the infected families, in acting on the advice given, both orally and by the free distribution of the usual printed pamphlets, strongly urging vaccination.

The result is that in many instances one after another in a household has caught the disease, which might have been avoided by a little promptitude.

Action taken.—The action taken, under the direction of the Sanitary Authority, by the Health Department, for the prevention of infectious diseases generally, includes the following ordinary measures:—

- 1.—Removal of the patient to Hospital wherever possible.
- 2.—Inquiry into the probable cause of the disease.
- 3.—Sanitary inspection of the infected premises, and removal of nuisances, &c.
- 4.—Disinfection and purification of infected rooms and their contents.
- 5.—Distribution of printed instructions for the information and guidance of the occupants of infected premises.
- 6.—Destruction of infected bedding, &c., in certain cases.

In addition to the above, the following extraordinary measures have been taken:—

- 1.—The Sanitary Authority have acquired extended legal powers for the prevention of infectious disease. (See page 40.)
- 2.—The staff of the Health Department has been increased, this being necessitated by the compulsory notification of infectious disease by medical practitioners, and by the prevalence of Small-pox, Typhus, and Scarlet Fever.
- 3.—The Ransome's Disinfecting Stove having been found unequal to the requirements,* the Authority have ordered a Washington Lyon's Steam Disinfecting Apparatus.
- 4.—Payment has been made to various persons for the nursing of patients at their own homes, when the removal of the patients to Hospital has not been practicable or advisable.

The foregoing have all been put into service in dealing with infectious disease generally. In the case of *Small-pox* the special action taken has included:—

- 1.—The reopening of the Small-pox Convalescent Home at Byker on August 16th for the reception of cases from Hospital. The Home has been kept in constant use up to the date of this Report (April.)
- 2.—The erection and fitting-up of a Temporary Hospital, and the necessary administrative department, nurses' rooms, &c., on the Town Moor.

* The cost of bedding to replace that destroyed on account of infection of different diseases during the year was upwards of £106.

- 3.—The Sanitary Committee have ordered an additional Ambulance, constructed on a new design, for the removal of patients.
- 4.—Returns of the localities where Small-pox has been prevalent have been constantly furnished to the Poor Law Authority for vaccination purposes. A printed copy of the pamphlet urging vaccination, as issued last year, has been left by the disinfectors at every house where Small-pox has been reported, and, when considered advisable, these pamphlets have been distributed freely in the neighbourhood of affected dwellings. Placards have also been posted in the different public baths and wash-houses, cautioning the public against the use of these places by infected persons, or for cleansing articles from infected houses.

Observations.—The value of vaccination as a protective against Small-pox is shown by the statistics of the cases treated in Hospital during the year (see Appendix B, page 64), which may be interpreted as follows:—The known vaccinated cases were 160 in number, with a mortality of 5 per cent.; the unvaccinated cases were 60 in number, with a mortality of 40 per cent.; the cases whose condition as to vaccination was doubtful were 2, with a mortality of 50 per cent.; the number of cases in which vaccination was reported to have been done, but in which no visible mark of the operation remained, was 19, with a mortality of 21 per cent.

The preventive power of vaccination against Small-pox is shown by the same Table to have been in the ratio of excellence of vaccination marks as judged by their quality and quantity—by good quality being understood distinctness of scar, with foveation or pitting. Thus, as regards *quality*—of the vaccinated 95 had good cicatrices, and the mortality of these was 2.1 per cent.; 65 had indifferent or very faint cicatrices, and the mortality of these was 5 per cent.

As regards *quantity* of vaccination scars:—Of the 95 well vaccinated Small-pox patients, 11 (3 suffering from the semi-confluent and 8 from the discrete or mildest form of the disease) bore only one vaccination mark, and none died; 36 (viz.: 1 confluent, 11 semi-confluent, and 24 discrete) bore two vaccination marks, and of these 1, or 2.8 per cent. died; 14 (all discrete) bore three marks, and none died; 15 (all discrete) bore four marks, and none died; 19 (viz.: 1 confluent, 3 semi-confluent, and 15 discrete) bore more than four marks, and of these 1, or 5.3 per cent. died.

65 had indifferent or very faint vaccination marks, and the mortality was 9.2 per cent. As regards such vaccination marks, quantity appears

to have, in some degree, made up for quality. Thus, 17 (4 confluent, 8 semi-confluent, and 5 discrete) bore one imperfect mark, and the mortality was 17.6 per cent.; 21 (5 confluent, 7 semi-confluent, and 9 discrete) bore two such marks, and the mortality per cent. was 9.5; 12 (1 confluent, 2 semi-confluent, and 9 discrete) bore three such marks, and the mortality was 8.3 per cent.; 7 (1 semi-confluent and 6 discrete) bore four such marks, and none died; 8 (1 semi-confluent and 7 discrete) bore more than four such marks, and none died.

Further, the complications of Small-pox were, generally speaking, more severe in the unvaccinated than in others. The unvaccinated patients more often suffered from Ophthalmia, Erysipelas, Abscesses, and Skin complications, than did the vaccinated.

One unvaccinated patient, aged 33 years, died from a reported second attack of Small-pox. The mother of the patient stated that he had had the disease when two weeks old, she herself being ill with it at the birth of the child.

Among the vaccinated was one of reported second attack of Small-pox. The case was very mild, and made a good recovery.

Among the cases bearing no vaccination marks, 8 were reported as having been unsuccessfully vaccinated, 3 of these each on two separate occasions, 2 others a few days before taking ill, and 1 four months before admission.

Among the moderately well vaccinated, one was reported unsuccessfully revaccinated ten years before. He had the disease in the semi-confluent form, and recovered well.

One of the patients, bearing three good vaccination marks, stated that he had been successfully revaccinated eleven years ago, one of the three marks being from revaccination; all three marks presented a similar appearance as though of the same age, and the result of one operation.

The most firm believers in *vaccination*—of whom the writer is one—deny the protective efficacy of much that passes under that name. Authorities maintain that a child is not properly “vaccinated” unless at least four distinct permanent, pitted scars (each about one-third of an inch in diameter, or confluent marks of an equivalent area) of the operation are left. But this plan of vaccination has not been acted up to in the past as is well known, and as the foregoing classification of “vaccination” scars shows. Hence, the doubt entertained by some persons of the utility of vaccination, even of the best kind, a doubt which will continue as long as imperfect vaccination is allowed to pass without liability to criticism by competent and independent inspectors.

Revaccination in infected houses and tenements should be compulsory. The experience of the present epidemic of Small-pox confirms what was already known, viz., that recently vaccinated persons do not take the disease at all, provided they are not infected before the operation is done. This fact is not properly grasped, especially by the poorer classes, to whom it is often impossible to bring the idea home so as to ensure promptitude of action, so important in the hour of danger. With the disease before their eyes and the printed pamphlet showing them how to protect themselves from it in their hands, they will delay and dally till too late. The following melancholy case, though occurring subsequent to the year under report, may be cited in illustration:—A man and his child, living in the Friars, were removed to Hospital suffering from Small-pox. The man's mother, who happened to be in the patient's house when the Medical Officer of Health called, was urged to be revaccinated with the rest of her family. She went to her home at Stepney, taking infection with her, but did not do as advised. About a fortnight after, another of her sons, living with her, fell ill, and was removed to Hospital. Revaccination was again advised, and again neglected. About two weeks later the father and mother and another son fell ill. When asked why she had not got revaccinated as urged, the mother said she "didn't know." This poor woman and her husband both died.

The apathy of the poorer classes in adopting preventive measure is matter of common knowledge, and this indifference is shown in nothing more markedly than with regard to revaccination.

If the revaccination of uninfected members of Small-pox-stricken households were compulsory, a strong check would be put on the spread of the disease.

As promptitude of action on such occasions is all important, it is necessary that the machinery for revaccination should be of the simplest character, and capable of being put into operation on very short notice. To prevent Zymotic disease is the duty of the Sanitary Authority, the custodians of the public health. Without in any sense reflecting on the administration of the law relating to vaccination and revaccination by the different Local Authorities throughout the country in whom this duty is now vested, it must be obvious to every one that a Sanitary Authority, duly informed of, and brought into contact with, each case of Small-pox as it arises, is the proper authority to inquire how far these cases depend on breach of that law, and, while there is yet time, to apply the means of protection to those exposed to danger. The following recent case, illustrative of the necessity of this, may be cited:—A married woman caught

Small-pox, and wished to be removed to Hospital; she had an unvaccinated infant, a few weeks old, at the breast, and there was no one but the mother to take charge of it. The doctor (a private practitioner) had no vaccine, and could not get any, and no one could be got to carry the child to the public vaccinator. The child could not be taken unprotected into Hospital, so the mother remained at home with it. The child caught Small-pox and died. Had the Sanitary Authority been also the Vaccinating Authority, the child might have been vaccinated on the day its mother's illness was notified.

TYPHUS.

107 cases of Typhus, including 30 deaths registered, have come under the notice of the department during the year. Of these, 74 were notified by medical practitioners subsequent to September 28th (see Appendix, Tables XVI., A and B).

History of the Outbreak.—The incidence of Typhus, during successive months of the year, on the different parishes or townships, as known to the department, is shown below:—

TYPHUS IN NEWCASTLE-UPON-TYNE.

NUMBER OF CASES KNOWN TO THE HEALTH DEPARTMENT.									
A. D. 1882.	Elswick.	Westgate.	St. Andrew's.	St. John's.	St. Nicholas.	All Saints.	Jeasmond.	Byker.	TOTAL.
January
February
March	1	...	1	1
April	1	1
May
June	1	1
July	5	5
August	3	...	1	2	6
September	2	...	6	8
October	2	1	13	...	3	19
November	1	1	3	16	...	7	28
December	1	1	4	16	...	15	37
TOTAL.....	2	1	5	2	8	55	...	34	107

The *general mortality* of Typhus to cases, for the last quarter of the year, calculated on deaths and cases notified during the same period, is 21·2 per cent. The mortality of Typhus in Hospital, calculated on admissions and deaths for the same period, is 17·7 per cent.

98, or above 91 per cent., of the cases known, were voluntarily removed to Hospital.

Although present in isolated cases in some parts of Newcastle during every month of the year except May, Typhus did not become to any extent prevalent until July, when several cases occurred in St. Ann's Street and neighbourhood. During the two following months the disease continued in this locality, and also spread to other parts of the City. In October the activity of Typhus increased, and a new area of infection appeared in and near the lower end of Pilgrim Street. More than half of the cases reported in Newcastle during the year occurred in All Saints' Parish, and about half of these were in the two areas of St. Ann's Street and the foot of Pilgrim Street. From these centres radiations of infection to other localities were easily traced.

It is interesting to note that, in accordance with previous experience, no infection of Typhus was extended to the population living near the Fever Hospital (see Disease Map).

Cause of Spread.—The spread of Typhus in 1882 is not difficult of explanation. In several of the areas invaded there had been cases of sickness not recognized as Typhus at the time of their occurrence, but which, viewed by the light of the subsequent undoubted fever cases, were evidently the same. The absence of disinfection or other preventive measures in these instances led to the dissemination of infection in various directions; and the well known character for age, dirt, crowding, and other sanitary defects, of the houses among the occupants of which the disease appeared, will readily serve to account for the hold it gained when once introduced. In one house of six single-room tenements in All Saints', Church Walk, occupied by twenty two persons, seven cases of Typhus were removed from five of the tenements. Three cases were removed from a room, part of which was an *old clothes shop* in Dog Bank.

The Action taken included the ordinary measures already named, and the adoption of every available means to secure removal of the fever-stricken with as little delay as possible. The efforts in this direction, considering the absence of power to compel isolation, were fairly successful. But the fact that about nine per cent. of the patients known to be suffering from Typhus were not taken to Hospital (owing chiefly, or solely, to their unwillingness to leave home), is a great cause of the spread of the disease to others, and an argument in favour of compulsory removal for their own and the public good.

ENTERIC (OR TYPHOID) FEVER IN NEWCASTLE-UPON-TYNE.

CASES KNOWN TO THE HEALTH DEPARTMENT.									
A.D. 1882.	Elswick.	Westgate.	St. Andrew.	St. John's.	St. Nicholas.	All Saints.	Jesmond.	Byker.	Total.
January	1	...	4	5
February...	...	1	1	...	2	4
March ...	4	1	1	2	...	4	...	6	18
April ...	1	2	3
May ...	1	3	4
June ...	2	2
July ...	3	1	1	4	9
August ...	3	1	1	1	...	3	9
September	2	1	4	1	8	16
October ...	5	6	2	1	1	13	...	16	44
November ...	3	3	1	...	1	8	1	4	21
December ...	5	1	4	...	10	20
TOTAL ...	29	12	4	5	5	36	2	62	155

The total number of deaths from Enteric Fever during the year is 30.

The *general mortality* of Enteric Fever for the last quarter of the year, calculated on deaths and cases notified during the same period, is 11·4 per cent.

Of the cases reported 18 only, or under 12 per cent. of the whole, were removed to Hospital. This is partly due to the fact that Enteric Fever is a disease affecting equally all ranks of life (hence in at least half of the cases removal is not even proposed); partly because the Hospital itself could not accommodate the cases during the latter half of the year; and partly because the risk of infection is not commonly so great in this fever as in others, hence there is not the same degree of urgency for removal.

History, Origin, &c.—The fact that upwards of half of the Enteric Fever under notice during the year occurred during the winter quarter is not so much due to increased prevalence of the disease as was the case with the two Zymotic diseases already considered. Notification of private cases under the Act during the winter quarter accounts to a considerable degree for the larger return in that period. Enteric Fever has, however, been actually more prevalent toward the close of the year, as the record of deaths testifies. Thus, of a total of 30 deaths from this cause, 8 were returned in the spring, 1 in the summer, 9 in the autumn, and 12 in the winter quarter respectively.

It is not intended to trace the cause of this disease by associating case with case, as no traceable connexion between the persons affected, through

the usual media, such as milk, water, or other tangible vehicle of contagium, is known to have existed. Reference to the Disease Map shows that Byker has suffered proportionally more than elsewhere. Here, with Enteric Fever, as with Small-pox, the district most affected is that to the south of Shields Road. Thus, in the area bounded on the north by Shields Road, on the south by Norfolk Road, on the east by Headlam Street, and on the west by Dalton Street, 28 cases were reported, or above 17 per cent. of those under notice in the entire City. In this area the privy midden system is in full operation, as the subjoined Table shows:—

Street.	Ashpits.		Privies.	Ash Closets.	Water Closets.	No. of Houses in Street.	No. of Tenements.
	Covered.	Open.					
Shields Road ...	1	44	85	68	128
Clifford Street ...	34	8	101	40	136
Corbridge Street	27	25	10	3	101	274
Parker Street ...	67	27	144	4	...	162	390
Conyers Road ...	40	42	135	...	2	105	290
Shipley Street ...	25	41	101	73	240
Norfolk Road ...	60	15	113	139	214
Totals ...	227	204	704	14	5	688	1,672

For the most part each house in the area has a privy discharging into an "ashpit," common to two houses and abutting on the back street, which is bounded on each side by these "conveniences." These "ashpits" are also privypits. Allowing 16 square feet as an average size of the "ashpits," there are in the area in question 6,896 square feet of surface for the storage of nightsoil and house-refuse—nearly half of which is exposed to the sun and rain! Last summer many of the middens in question were found to be in a very offensive state, those without roofs having water standing in them. All appeared to be uncemented, and the brickwork of many was saturated with organic liquid oozing from within. Since the subject was brought forward in summer, the Inspector of Nuisances reports that the "ashpits" were cleaned and drained, and the floors of some have been cemented. No other improvement is recorded. The evils of the privy midden system continue unabated, and to them may be attributed, indirectly if not directly, much of the Zymotic disease from which the area has suffered during the year.

Among the cases illustrating *how Enteric Fever may be spread* (although it is but just to state that, happily, no such spread is known to have taken place from these examples), the following have been noted:—

In March two cases of Enteric Fever (one fatal) occurred at a small shop in — Street from which *milk was sold*. As the removal of

the non-fatal case was not allowed, the discontinuance of the sale of milk was advised and agreed to, and the usual disinfection, &c., was done.

In the same month two cases of Enteric Fever occurred in a house in — Street, consisting of two small living and sleeping rooms, one of which was also a *provision shop* open to the public in which one of the patients was lying. The patients were removed to Hospital.

In the same month a patient was removed to Hospital, after about a fortnight's illness, from a house in Stone Street. The mother earned her living by *taking in washing*, which was done on the premises.

In October a case of Enteric Fever in the family of a *Dairyman*, at — Street, was notified. An undertaking was given that the milk business should be entirely separated from the infected premises.

The action taken for the prevention of the spread of Enteric Fever has been already described under the account of Ordinary Preventive Measures (p. 21). Special attention in this disease was always directed to possible defects of drainage and water or milk supply.

SCARLET FEVER IN NEWCASTLE-UPON-TYNE.

CASES KNOWN TO THE HEALTH DEPARTMENT.									
A. D. 1882.	Elswick.	Westgate.	St. Andrew's.	St. John's.	St. Nicholas.	All Saints.	Jesmond.	Byker.	Total.
January	7	3	...	1	4	...	2	17
February ...	4	2	3	10	...	2	21
March ...	7	2	...	2	1	1	...	1	14
April ...	1	4	...	1	...	2	8
May ...	5	4	1	3	...	3	16
June ...	8	2	1	1	...	6	...	1	19
July ...	3	...	3	2	...	4	12
August ...	5	9	2	...	1	1	1	1	20
September ...	15	3	5	...	1	8	...	10	42
October ...	33	12	14	4	3	19	...	12	97
November ...	34	14	6	3	2	16	7	19	101
December ...	14	9	11	2	...	13	2	22	73
Total ...	129	68	46	13	12	85	10	77	440

The total number of deaths from Scarlet Fever during the year is 82.

The *general mortality* of Scarlet Fever for the last quarter of the year, calculated on deaths and cases notified during the same period, is 9.4 per cent.

Of the 440 cases of Scarlet Fever in the City, 2 only were removed to Hospital (see Appendix A, Table XIII.) On different occasions persons suffering from Scarlet Fever were unable to gain admission.

History and Causes of Spread.—The history of Scarlet Fever in 1882 is shown by the preceding Table, from which it appears that cases have occurred every month, and that the disease was on the increase prior to the operation of the provisions for the notification of infectious disease. The fact, that the larger part of the cases brought under the notice of the department occurred during the December quarter is not entirely attributable to the action of the before-mentioned legal provisions, is confirmed by the return of deaths under this head, from which 29 or above 35 per cent. of the whole, occurred in the winter quarter.

On looking at the Disease Map it will be seen that Scarlet Fever has been wide spread, few of the populous parts of Newcastle having been entirely free from it. Certain streets have been affected more markedly than others, the cases appearing there in little clusters. Among the more notable of these streets may be named Stanley Street (Elswick), Bell Terrace, Hawes Street, Bowman Terrace, Railway Terrace, George Street West, Buckingham Street, Liverpool Street, Pilgrim Street (lower part), St. Anthony's, &c. There was also a group of cases at the Deaf and Dumb Asylum. These different groups indicate pretty clearly that the spread of infection has been due to direct personal communication between the infected and the non-infected in consequence of imperfect isolation of the former. The character of the dwellings of most of the before-mentioned streets is well known to be such as to render proper segregation of a case of infectious sickness in them a matter of practical impossibility. Considering that so little has been done for the isolation of Scarlet Fever in Hospital, it is almost surprising that the cases of this highly contagious disease have not been more numerous.

Wards for the treatment in Hospital of Scarlet Fever are much needed. From familiarity with this scourge of youth, the public mind seems to have grown callous towards it; otherwise, special provision would have been made in respect of it. Small-pox did not occasion nearly so many cases or deaths last year as Scarlet Fever, yet the former occupied a much larger share of public attention than the latter; and as a reflex of popular feeling on the subject, a new hospital (to supersede an old one already existing) was erected for the less prevalent disease, whereas the more prevalent malady is still unprovided for.*

Among the special cases illustrating *how Scarlet Fever may be spread*, the following were met with in 1882:—

(a.)—*At Dairies, &c.*—In February information was received from the Medical Officer of Health to a neighbouring Rural Sanitary Authority

* It is expected that the Sanitary Hospital about to be erected will contain the necessary accommodation.

that milk produced in his district at a *dairy farm*, on which there were several cases of Scarlet Fever, was being sold in Newcastle. Steps were at once taken to have the milk business separated from the infected premises, and it was understood that the Rural Inspector would keep the place under surveillance so long as infection continued there.

In May information of an outbreak of Scarlet Fever at St. Anthony's was forwarded to the Department. Six families were found to be affected, and there were thirteen cases. Several of the affected families were being supplied with milk by a dairyman in whose house the disease was. As soon as this was ascertained, steps were taken to separate the dairy business from the infected premises.

In October a case of Scarlet Fever was notified in the family of a dairyman occupying a single room tenement at — Lane. The dairyman sold only milk brought from the country. The milk vessels were in the house at the time of the Inspector's visit. The separation of the milk and vessels from the infected premises was required.

(b.)—*By Messengers, &c.*—Scarlet Fever was last year prevalent in — Terrace. In March there were four cases in one family, one of the members of which was found to be acting as an errand boy at a shop in the vicinity, although mingling with his relatives at home. On being spoken to, the parents kept the boy at home. The usual disinfection was done.

(c.)—*At Common Lodging Houses.*—In April a case of Scarlet Fever came under notice at a common lodging house at No. —, Silver Street. The case had not been reported to the Inspector of Lodging Houses as required by the regulations. Proceedings were instituted against the keeper of the lodging house, who was fined 10s. and costs.

(d.)—*By Old Clothes Shops.*—In May a case of Scarlet Fever in an *old clothes shop* at No. —, Dog Bank, was reported. The father calls at better class houses to purchase clothes, which are sold partly from the house, a tenement of one room only, occupied by the family as a living and sleeping room and also used as a shop; the mother also sells clothes in the Milk Market on Saturdays. The father refused to allow the boy to be removed to Hospital. He agreed to let the old clothes be taken away for disinfection, and undertook to provide a separate room, away from the house, in which to place them after disinfection. The latter undertaking was not fulfilled.

DIARRHOEA.

Diarrhoea was, as usual, prevalent in the autumn. There were 118 deaths in the third quarter of the year, as compared with 85 in the

previous autumn, and 133 in that of 1880. The total deaths from this cause for the year under report was 159. An inquiry into the outbreak of Diarrhœa in autumn was made by the Medical Officer of Health on the request of the Local Government Board, at the instance of their Medical Inspector, Dr. Ballard, who visited Newcastle and other towns in connexion with the investigation, which comprised:—

- 1.—Circulation among the profession of books of blank forms for observations on (a) cases of Diarrhœa, &c., and (b) statistics of infant alimentation.
- 2.—The special return from the Registrars of all deaths from Diarrhœa, &c., and the immediate visitation at the houses of the deceased (126 cases in all), for the purpose of noting down particulars under about sixty heads relating to:—
 - (a) Parents of deceased (age, occupation, &c.)
 - (b) History of illness of deceased.
 - (c) Mode of feeding deceased.
 - (d) Sanitary condition of residence of deceased.
- 3.—The preparation of a register for Newcastle, divided into census enumeration areas, and showing the street and number of the house, age of deceased, and other particulars of each death from Diarrhœa, &c., and also the deaths of children under five years of age from other causes, during the three past years.
- 4.—The preparation of a plan of Newcastle showing the census enumeration areas, to correspond with the above register.
- 5.—Classification of births during the three past years, according to the streets in which they occurred. (Not yet completed.)

The enquiry extended over the autumn quarter, and occupied a considerable portion of each week day.

(2.)—SANITARY DEFECTS OF HOUSE PROPERTY IN BLOCK.

Among the different blocks of house property under special inspection for sanitary defects have been the following:—

Windsor Terrace.—An inspection of the south side of this terrace of valuable houses was made in the early part of the year, having been set on foot by the complaint of a resident as to the state of the house he occupied, aided by the knowledge already possessed by the department respecting the condition of another of the houses (see Annual Report, 1880, page 23). The inspection disclosed several insanitary conditions. Many of the houses had soil-pipes in the interior, passing from back to front beneath the basement, kitchens, &c. The ventilation of the soil-pipes was in several instances imperfect; all of the stack pipes, the kitchen

sinks, and many of the other waste pipes were found connected directly with the drains, often passing beneath the larder, &c. The course of the soil-pipes from back to front in this block is more than usually dangerous from the fact that many of the back main walls are hollow, and communicate with bedrooms by grated openings intended to act as exhausts for foul air, but which, in the case of the house examined in 1880, served to lay on a constant supply of sewer air from a leaking soil-pipe, which traversed the hollow wall near the foundations. The main sewer in the back street was not sufficient to drain the houses and was relaid in 1882 by the City Engineer at a greater depth so as drain all the houses on the south side of the Terrace. The owners were then communicated with and requested to rearrange their house drains so as to discharge into this sewer. As yet, four houses only have been altered as required. Illustration sketches* of the drainage arrangements of some of the dwellings on each side of Windsor Terrace are given in Appendix C.

It was proposed to extend the inspection through the north side of the Terrace; and with this view a beginning was made, but owing to the difficulty experienced in carrying out the alterations required in houses already referred to, the project has been laid aside for the present.

Meldon Terrace, Heaton.—On examination in February, this block of dwellings was found to have several sanitary defects common to all of the houses. The waste- and rain-pipes discharged into the soil pipes, and the latter acted as ventilators to the sewer, their upper ends being near bedroom windows. The cellar drains were in connexion with the sewer; the sewer itself was obstructed. The Inspector of Nuisances reports that all the sanitary works required, including the sealing up of the cellar drains, have been executed. The sewer also, which was obstructed, was cleaned out by the instruction of the City Engineer.

Jesmond High Terrace.—A new sewer having been lately laid in the back street by the City Engineer, the sanitary arrangements of the mansions of this terrace were examined and found to be very defective. The house drains were afterwards taken to the sewer at the back; the waste-pipes were disconnected; the soil pipes, wherever this was practicable, were carried to the outer air and were properly ventilated; the privies in the yards were replaced by water closets. An arrangement for trapping and disconnecting from the sewer and ventilating the entire length of the house drain, as recommended by the City Engineer, was carried out in most of the houses. A sketch of the sanitary defects found in one of the houses, and the alterations made, is given in Appendix C.

* Prepared by the Chief Inspector of Nuisances, Mr. W. T. Clarke.

Fenwick Terrace, Jesmond.—This terrace, inspected in consequence of cases of sickness in one of the houses, showed a defective system of main sewerage and several insanitary conditions in the dwellings. The former, which is to a great degree dependent on the major subject of the sewerage of Jesmond Vale, waits the carrying out of the projected improvements in that direction; the latter have had the defects remedied in such cases as have come under notice.

A typical illustration of the sanitary defects of the houses in the terrace, taken from the property sketch book of the Chief Inspector, is given in Appendix C.

Attention has also been required to various dwellings on the banks of the Jesmond Burn, in an insanitary state from the sewage with which the stream is polluted.

Half-Moon Yard, Bigg Market.—This block containing, in addition to the inn, tenement property, workshops, &c., was found to be insufficiently provided with "conveniences," and to have other sanitary defects. The Inspector of Nuisances reports that all the required works have been done.

At *High and Low Folds, Byker Bank*, several dilapidated houses, unfit for habitation, have been closed. The large yards known as the "Folds," are still unpaved and in an insanitary state. There are also on the premises several wooden sheds without drains or manure receptacles, and improperly used as stables.

At *Percy Court, Percy Street*, the upper block, consisting of fourteen tenements, has been provided with additional closet accommodation.

Leighton's Buildings, Quality Row.—In this large block of tenement dwellings the closet accommodation is deficient for the requirements, if all the tenements were occupied; but as more than half of the rooms are empty the only action taken has been to require the existing closets to be repaired and ventilated, which the owner has done.

Cool's Yard, Quality Row, and *Appleton's Buildings, Ouseburn*, have been provided with extra closet accommodation in compliance with requirement.

Vint's Buildings, New Road.—This block of tenement property was reported to the Sanitary Committee in February as having on the premises an offensive public privy and large open midden, a stable without manure receptacle, the manure being deposited on the ground, as also were ashes and night-soil; the yard was unpaved. As the result of notices served to abate the nuisances other than those due to absence of paving, the Inspector reports that the works have been done as ordered. The ground is still unpaved.

(3.)—SANITARY DEFECT OF HOUSE PROPERTY NOT IN BLOCK.

Among the noteworthy examples met with under this head, illustrating the character of the difficulties to deal with, the following, which were reported to the Sanitary Committee, may be mentioned:—

- 1.—No. —, Prudhoe Street, a house occupied by three families; reported on in March as having no "convenience" of its own, the occupants using the water closet of an adjoining house. The closet in question, which was in the basement and in an unsuitable position, was obstructed and offensive. The Committee ordered that proceedings should be taken against the owner unless the required improvements were carried out. The Inspector reports that the works have been done.
- 2.—Reported in May. A room at No. —, St. Ann's Street, closed on legal notice as being unfit for habitation, afterwards relet without authority or remedy of sanitary defects. Again closed on further notice.
- 3.—Same month. At No. —, Wood Entry, St. Ann's Street; one water closet for a block of eight tenements, and placed under the stairs in the interior of the house. The closet had been fastened up for some time on account of its offensive smell. There was no ventilation to either closet or soil pipe, and the house was reported to be unfit for habitation from the nuisance and the want of proper accommodation. The Inspector reports that this water closet has been "repaired and put into proper order." *This is not enough: for, so long as the closet remains in its present position and unventilated, the numerous occupants are exposed to danger from liability to escape of sewer-gas into their dwellings and nuisance from obstruction.* The difficulty is to find another place for the closet, there being no available space outside the house.
- 4.—Same month. At Scott's Entry, Sandgate, the tenement property belonging to Mr. _____, occupied by seven tenants, was reported to have only one water closet, which was situated beneath a living and sleeping room. The property owned by Mr. _____ in the same entry, was reported to have only one water closet for the use of thirteen tenants. This closet also was beneath a living and sleeping room. The Inspector reports that in both cases the rooms over closets, and several others, were closed under legal notice.

The foregoing common examples of difficulties encountered by the Inspector of Nuisances, show the need of decided and radical action to procure any real improvement in the sanitary condition of some of the old tenement property of Newcastle.

(4.)—REFUSE REMOVAL.

Under this head is to be noticed the common practice of making improper deposits of night-soil, slops, and other refuse, on the roadways and street gully grates. A list of some forty streets where such deposits were regularly made was furnished by the City Engineer. The Inspectors have exerted themselves to put a stop to this practice, and the police have been communicated with on the subject; but, as offenders are seldom caught in the act, the nuisance continues with but little abatement.

(5.)—REMOVAL OF CORPSES TO THE DEAD-HOUSE, &c.

This matter, which has frequently been a subject for unfavourable comment in former Reports, has now, in all probability, been satisfactorily arranged for under "The Newcastle-upon-Tyne Improvement Act, 1882," in which provision is made for the burial of corpses of poor persons, without their previous removal to the common dead-house. The new arrangement, so far as it has been tried, works well. The forms and details introduced in connexion with the interment of corpses from the Fever and Small-pox Hospitals and the houses of the poor, are matter for the Report of 1883.

(6.)—DAIRIES, COWSHEDS, AND SLAUGHTER HOUSES.

Owing to the restrictions on the movement of cattle, under the Contagious Diseases (Animals) Act, and the consequent occupation of Inspector Hedley's time, the inspection of cowsheds, dairies, and slaughter houses—which is the duty of the same officer—has not been carried out so systematically as it would otherwise have been.

Outbreaks of Pleuro-pneumonia in cow-houses at Elswick East Terrace and Spital Tongues in spring, involving the slaughter of 102 cows (10 diseased and 92 others that had been in contact with them), led to several improvements of the premises, such as cementing of the ground, ventilation, roofing of manure receptacles, &c.

The Inspector reports that notices have been served on nine occupiers of defective cowsheds at New Mills, to improve the lighting, ventilation, cleansing, drainage, and water supply thereof; part of the required work has been executed and part remains to be done. One cowshed at Back Wellington Street has been cemented and provided with water after notice given.

Five persons have made application to begin to occupy buildings as cowsheds which have not been previously occupied as such. After being reported on, one application was granted by the Committee and four were refused, chiefly on account of sanitary defects of drainage and cementing, or proximity to dwelling houses.

There have been eight outbreaks of infectious disease in the families of cow-keepers, viz.:—Four of Scarlet Fever, two of Small-pox, and one each of Enteric Fever and Measles. On report of the cases they were at once attended to by the Inspector, and no subsequent extension of the respective diseases by means of milk is known to have occurred.

Slaughter-houses.—During July and August, a careful inspection was made of the licensed slaughter-houses and triperies, according to the form given in Appendix G. There are three principal groups of these, viz.:—One at Dispensary Lane, one at Stepney, and one at the Cattle Market; the other slaughter-houses, &c., are scattered over the City, and as the occupiers generally live at a considerable distance, it is often difficult to gain admission to the premises to see that the regulations are complied with. There are 151 licensed places (137 slaughter-houses and 14 triperies). Of these, 10 were unoccupied at the time of inspection. The results of the inspection were submitted to the Sanitary Committee, who decided to withhold the license from one place—a wooden shed without drainage or water supply—and to grant licenses for six months only to twenty-nine others in close proximity to human dwellings, with the view of giving time to the occupiers to make other arrangements before further action should be taken.

Five persons have made application for licenses to use premises as slaughter-houses. After hearing the reports thereon, the Committee granted two of the applications and refused the others.

(7.)—FLAGGING, PAVING, AND SEWERING.

A separate report on these and other matters is in course of preparation by the City Engineer.

(8.)—GENERAL WORK OF THE SANITARY STAFF.

(a.)—*Nuisance Removal.*—2,309 cases of nuisance have been dealt with during the year by the Inspectors of the Health Department. A classified list of the cases is given in Appendix A, Table XVII., which shows the number and nature of the nuisances dealt with by each district inspector. The total is about 38 per cent. less than in the preceding

year. The decrease is accounted for by the larger than usual amount of disinfections which the inspectors were required to do, to the interruption of their ordinary duty (see subsequent paragraph on *Disinfection*).

Of the nuisances 191, or about 9 per cent., have been remedied on simple request (verbally or by letter) to that effect made to the owner or agent of the property by the Chief Inspector; the remainder have been remedied on service of formal (legal) notice. In no instance during the year has it been found necessary to take proceedings before the magistrates for the removal of a nuisance. The Chief Inspector reports that all formal notices served have been complied with.

In connexion with this subject, it is hoped that the course adopted since March (when Mr. Clarke entered on his appointment as Chief Inspector of Nuisances), of invariably in the first instance communicating, verbally or by letter, with property owners as to nuisances or sanitary defects, before serving the usual legal notice and on the expiration of the time specified in such notices, will meet with general approval. This custom gives extra trouble to the inspector, but the attention is appreciated by property owners, and, so far as can be judged by nine months' experience, is likely to be productive of good results by leading in an agreeable manner to the execution of sanitary works. To further this, the advice of the Medical Officer of Health or Inspector (who is always ready with reasonable and practicable proposals) may be had on application.

In the list of matters within the scope of the Health Department the inspection of common lodging-houses does not find a place, as this section of sanitary work in Newcastle is and has always been attended to by the police. In one instance, however, owing to the structural defects of a long-existing common lodging-house at No. —, Pudding Chare, to which the attention of the Medical Officer of Health had been drawn in 1881 by the prevalence of Enteric Fever on the premises, the re-registration of the house in 1882 was opposed by the Sanitary Committee, unless and until certain alterations were made.

Among other works begun in the Health Department during the year is that of systematic *house-to-house inspection*, which was arranged for during last summer, but owing to the epidemic disease requiring the attention of the inspectors, was not put fully into operation until 1883, when the staff was increased. This inspection is intended to include the examination of every house in the City, and the compilation of details as to the sanitary condition of each under different heads.* In the course of this

* See form, Appendix H.

work defects in the sanitary arrangements of houses will be noted and dealt with, and sketch plans will be made and filed by the Chief Inspector of any special structural faults, &c. In this way a valuable record will in course of time be formed.

(b.)—*Disinfection*.—The houses or rooms connected with 1,186 cases of infectious disease have been disinfected by the inspectors during the year, or more than double the number so treated in 1881 (see Appendix A, Table XVI. A). The amount of infected bedding and other articles purified at the disinfecting station was also greater than usual (see Appendix A, Table XVI.) The disinfecting apparatus was insufficient for the demand made on it, although for months kept working night and day almost without intermission; consequently a great deal of bedding was of necessity either destroyed and replaced, or merely fumigated at the houses where the disease occurred. The Committee have ordered a Washington Lyons Steam Disinfecting Apparatus, in which the articles will be purified more rapidly than is possible at present in the Ransome Gas Stove.

Owing to the demands of epidemic and general work on the department, it has been necessary to increase the staff by the addition of two disinfectors. The District Inspectors are now relieved from duties connected directly with infectious disease.

The duty of inspecting Fish in the Fish Market has been transferred from a special officer to the Chief Inspector of Nuisances, and the duty of inspecting Slaughter Houses has been transferred from the District Inspector of Nuisances to the Inspector of Provisions, Dairies, and Cattle.

(9.)—UNWHOLESOME PROVISIONS.

A list of Unwholesome Provisions inspected is given in Appendix A, Table XIV. The return does not differ materially from those of former years, and does not call for special comment.

Among the sanitary provisions obtained in the Newcastle-upon-Tyne Improvement Act, 1882, are several relating to human food. Section 33 is an extension of Sections 116 to 119, inclusive, of the Public Health Act, 1875, to "All articles intended for the food of man sold or exposed for sale, or deposited in any place for the purpose of sale or of preparation for sale within the city."

Section 34 of the local Act gives power to the Medical Officer of Health or Inspector of Nuisances to open boxes, &c., for the purpose of effectually examining articles of food under Section 116 of the Public Health Act, 1875.

Section 35 is an extension of Section 117 (Power of Justice to order destruction of unsound meat, &c.) of the Public Health Act, 1875, to "every diseased, unsound, or unwholesome article of food sold or exposed for sale, or deposited in any place for the purpose of sale, *whether such article be seized or be not seized and carried away to be dealt with by any Justice.*"

(10.)—BUILDING PLANS.

Owing to want of time the Medical Officer of Health has been obliged to discontinue temporarily the examination, for sanitary purposes, of Building Plans. It is not proposed to offer any remarks on the plans examined.

The following has been kindly supplied by the City Engineer, Mr. W. Geo. Laws:—

HOUSES BUILT DURING THE YEAR 1882.		
District.	Self-contained.	Flats.
Jesmond	54	—
Byker	8	71
Westgate	25	46
St. Andrew's	4	2
Elswick	3	29
Heaton	22	35
All Saints'... ..	1	—
	117	183
		2
		—
	Houses...366	—

New accommodation has thus been provided for 483 families, or, at the rate of five persons to a family, 2,415 persons.

(11.)—SANITARY LEGISLATION.

Among the important duties fulfilled by the Sanitary Authority during the year are the provisions for the protection of the public health acquired by them under the Newcastle Improvement Act, 1882, the details of which it is unnecessary to recapitulate.

In the outset the sections of the Bill relating to Infectious Disease met with opposition from a minor section of the medical profession, and a petition, signed by upwards of thirty medical men, was filed against them. It is satisfactory to be able to report that so far as is known this feeling has subsided; some of the former active opponents to the "Notification Clauses" have expressed their satisfaction with the working

of them since they came into operation. In giving effect to these clauses, the profession and the public may rest assured that due respect will be paid to the rights and feelings of private individuals, and every effort put forth to gain the confidence and approval of those to whom they refer.

In the original draft of the Bill power was sought to compel removal to Hospital of persons suffering from infectious diseases in certain cases, also to maintain patients in Hospital at the cost of the Corporation in certain cases. Both clauses were struck out by the Select Committee of the House of Commons appointed to consider the different Bills.

(12.)—WELL WATERS, &c.

Samples of water from three wells, &c., have been drawn and submitted to the Public Analyst, Mr. John Pattinson, for his examination and report. One of these, taken from premises at No. — Westgate Road, was found to be impure. The well was closed by order of Committee. One, taken from a well at The Grove, Jesmond, was found to be fit for drinking purposes. The remaining samples, five in number, were taken at different times from one source, viz., the pant on the Leazes, near St. Thomas' Street, and the spring by which the pant is supplied. The analysis showed that the water became slightly contaminated with lead in its course through the lead pipe between the spring and the pant, the contamination being traceable in water that had stood in the pipe overnight. The Committee ordered that the pipe should be replaced by one of other material. The cost of the work is included in the Engineer's estimates for the ensuing year.

The spring water supplied to the trough near the foot of Bath Lane having been reported to be polluted and offensive, the Committee ordered that it should be turned into the sewer and replaced by the Company's water, which has been done by the Engineer.

HENRY E. ARMSTRONG,

MEDICAL OFFICER OF HEALTH.

Health Department,
Town Hall,
2nd April, 1883.

City and County of Newcastle-upon-Tyne,

1882.

APPENDIX A.

TABLE I.

POPULATION (ESTIMATED BY THE REGISTRAR GENERAL TO THE MIDDLE OF THE YEAR)—147,626.

Registration Sub-Districts.	Births Registered in 52 Weeks, ended 30th December, 1882.					Deaths Registered in 52 Weeks, ended 30th Dec., 1882.		
	Male.		Female.		Total.	Male.	Female.	Total.
	Legitimate.	Illegitimate.	Legitimate.	Illegitimate.				
Westgate	1,154	48	1,078	45	2,325	677	649	1,326
St. Andrew's	253	14	220	17	504	182	172	354
St. Nicholas'	139	5	127	5	276	274	171	445
All Saints'	466	20	444	35	965	281	291	572
Byker	684	29	670	22	1,405	370	336	706
Total	2,696	116	2,539	124	5,475	1,784	1,619	3,403

The births represent a rate of 37·0, and the deaths a rate of 23·0 per 1,000 estimated population. The increase of births over deaths is 2,072.

TABLE II.

ANNUAL DEATH-RATE PER 1,000 LIVING IN NEWCASTLE FOR THE PAST FIVE YEARS, COMPARED WITH THE AVERAGE RATE IN 23 LARGE TOWNS IN THE UNITED KINGDOM.

	1878.		1879.		1880.		1881.		1882.	
	Annual Average in 23 Towns.	Annual Rate in Newcastle.	Annual Average in 23 Towns.	Annual Rate in Newcastle.	Annual Average in 23 Towns.	Annual Rate in Newcastle.	Annual Average in 23 Towns.	Annual Rate in Newcastle.	Annual Average in 23 Towns.	Annual Rate in Newcastle.
1st Quarter	25·5	23·2	27·8	25·3	25·5	23·1	23·8	21·7	24·3	22·8
2nd "	23·2	22·0	22·7	25·3	20·4	21·8	20·5	21·8	20·9	21·0
3rd "	23·5	25·4	18·4	20·8	23·2	22·7	20·5	21·4	20·6	24·4
4th "	25·2	24·1	24·6	22·7	21·5	20·8	22·1	21·0	22·9	23·9
Annual Rate	24·4	23·7	23·4	23·5	22·7	22·3	21·7	21·7	22·3	23·0

TABLE III.

RATES OF DEATH IN THE DIFFERENT CLASSES OF DISEASES PER 1,000 POPULATION IN THE CITY, AND IN EACH REGISTRATION SUB-DISTRICT.

Registration Sub-Districts.	Westgate (V.W.)* excluding Benwell and Fenham.	St. Andrew's.	St. Nicholas' (H.)†	All Saints'.	Byker.	City.
Population (estimated to middle of 1882)	62,542	18,958	9,976	24,674	31,476	147,626
CLASS.	Rate per 1,000	Rate per 1,000	Rate per 1,000	Rate per 1,000	Rate per 1,000	Rate per 1,000
1. Zymotic† ...	4.0	2.7	5.7	4.7	5.5	4.4
2. Constitutional ...	3.6	3.0	5.7	3.8	3.5	3.7
3. Local ...	8.6	9.3	17.9	9.3	7.8	9.5
4. Developmental ...	3.8	2.8	3.9	3.4	4.4	3.8
5. Violent Deaths (classified)	0.5	0.2	4.2	0.7	0.6	0.7
6. Do. (not classed)	0.1	0.05	0.6	0.2	0.1	0.1
Sudden Deaths (causes unascertained, causes not specified, or ill-defined)	0.8	0.5	2.0	1.4	0.7	0.9
Totals ...	21.4	18.55	40.0	23.5	22.6	23.1

* Workhouse and Vagrant Ward.

† Hospital.

‡ The deaths in the Zymotic Class are corrected by distribution of those occurring at the Fever Hospital to the Sub-district from which each came.

TABLE IV.

DEATHS FROM ALL CAUSES IN EACH SUB-DISTRICT.

ORDER.	Westgate.	St. Andrew's	St. Nicholas'	All Saints'.	Byker.	TOTALS.	
	Number of Deaths.	Number of Deaths.	Number of Deaths.	Number of Deaths.	Number of Deaths.	Deaths from all Causes.	Percentage of Total Deaths in each of the different orders to total deaths from all causes.
CLASS I. ZYMOTIC DISEASES.							
1. Miasmatic ...	210	39	91	88	152	580	17.0
2. Ethetic ...	7	4	4	4	3	22	0.6
3. Dietic ...	22	2	7	10	2	43	1.2
4. Parasitic ...	3	1	...	4	0.1
	242	45	102	103	157	649	19.0
CLASS II. CONSTITUTIONAL DISEASES.							
1. Diathetic...	33	12	14	14	20	93	2.7
2. Tubercular ...	194	46	43	82	92	457	13.4
	227	58	57	96	112	550	16.1
CLASS III. LOCAL DISEASES.							
Diseases of—							
1. Nervous System...	191	54	54	82	76	457	13.4
2. Organs of Circulation ...	82	27	34	26	28	197	5.7
3. Respiratory Organs ...	175	62	43	99	104	483	14.1
4. Digestive ...	53	18	25	14	27	137	4.2
5. Urinary ...	23	16	14	7	8	68	1.9
6. Organs of Generation ...	7	1	3	...	1	12	0.3
7. „ Locomotion ...	2	2	5	1	...	10	0.2
8. Integumentary System...	3	1	1	1	4	10	0.2
	536	181	179	230	248	1374	40.3
CLASS IV. DEVELOPMENTAL DISEASES.							
Diseases of—							
1. Children ...	45	11	7	13	48	124	3.6
2. Adults ...	8	5	4	2	10	29	0.8
3. Old People ...	90	14	7	17	17	145	4.2
4. Nutrition...	95	24	21	53	65	258	7.5
	238	54	39	85	140	556	16.3
CLASS V. VIOLENT DEATHS.							
1. Accident or Negligence...	26	3	42	15	19	105	3.0
2. Homicide ...	1	1	2	0.05
3. Suicide ...	2	2	...	3	...	7	0.2
4. Executions
	29	5	42	18	20	114	3.3
Violent Deaths not classed	7	1	6	5	5	24	0.7
Sudden Deaths (causes unascertained)	...	2	1	3	3	9	0.2
Causes not specified or ill-defined ...	47	8	19	32	21	127	3.7
	54	11	26	40	29	160	4.7
Totals ...	1,326	354	445	572	706	3,403	

* The number of deaths in St. Nicholas' Sub-district is increased by 248 deaths in the Infirmary, and 56 in the Fever and Small-pox Hospitals; 83 of the former came to that Institution from beyond the City.

TABLE V.—AGES AT DEATH.

Periods.	Westgate.	St. Andrews'.	St. Nicholas'.	All Saints'.	Byker.	Total in City.
Under 1 Year ...	360	86	65	176	227	914
1 Year and under 5 Years...	176	51	46	96	141	511
5 Years " 20 " ...	90	27	60	64	72	312
20 " " 40 " ...	185	42	105	81	88	496
40 " " 60 " ...	205	70	101	76	92	548
60 " " 80 " ...	263	63	59	65	73	523
80 " and upwards ...	47	15	9	14	13	99
Total (all ages) dying during the 52 weeks ended 30th Dec., 1882	1,326	354	445	572	706	3,403

TABLE VI.

WEEKLY MEAN NUMBERS OF DEATHS AT SEVEN ÆTAL PERIODS.

Periods.	Westgate.	St. Andrews'.	St. Nicholas'.	All Saints'.	Byker.	Total in City.
Under 1 Year ...	6.9	1.6	1.2	3.3	4.3	17.5
1 Year and under 5 Years...	3.3	0.9	0.8	1.8	2.7	9.8
5 Years " 20 " ...	1.7	0.5	1.1	1.2	1.3	6.0
20 " " 40 " ...	3.5	0.8	2.0	1.5	1.6	9.5
40 " " 60 " ...	3.9	1.3	1.9	1.4	1.7	10.5
60 " " 80 " ...	5.0	1.2	1.1	1.2	1.4	10.0
80 " and upwards ...	0.9	0.2	0.1	0.2	0.2	1.9
Totals ...	25.2	6.5	8.2	10.6	13.2	65.2
Percentage of Deaths under 1 Year to total Deaths in Sub-District, &c. ...	27.1	24.2	14.6	30.7	32.1	26.8

TABLE VII.

BIRTHS AND DEATHS IN THE DIFFERENT QUARTERS IN THE YEARS 1879, 1880, 1881, 1882.

	BIRTHS.				DEATHS.			
	1879.	1880.	1881.	1882.	1879.	1880.	1881.	1882.
First Quarter ...	1,371	1,378	1,392	1,347	929	862	825	843
Second " ...	1,366	1,462	1,342	1,328	930	848	790	775
Third " ...	1,345	1,322	1,309	1,435	765	849	781	902
Fourth " ...	1,299	1,273	1,290	1,365	834	776	768	883
Totals ...	5,381	5,435	5,333	5,475	3,458	3,335	3,164	3,403

TABLE VIII.

DEATHS OF CHILDREN UNDER 1 YEAR AND PERSONS OVER 60 YEARS IN 1879, 1880, 1881, 1882.

	NUMBER OF DEATHS.							
	Under 1 Year of Age.				Over 60 Years.			
	1879.	1880.	1881.	1882.	1879.	1880.	1881.	1882.
First Quarter ...	215	223	166	190	153	166	189	167
Second " ...	199	225	182	210	189	150	184	141
Third " ...	212	294	273	320	119	122	147	126
Fourth " ...	158	185	199	194	120	174	148	188
Totals ...	784	927	820	914	581	612	668	622

TABLE IX.

DEATHS OF CHILDREN UNDER ONE YEAR OF AGE DURING THE 52 WEEKS ENDED 30TH DECEMBER, 1882.

CLASS.	CAUSE OF DEATH.	Westgate.	St. Andrews'.	St. Nicholas'.	All Saints'.	Byker.	Total in City.	
I.—ZYMOTIC DISEASES.	ORDER 1.							
	Small-pox ...	2	1	2	...	2	7	
	Measles	1	2	3	
	Scarlet Fever (Scarlatina) ...	1	...	1	2	...	4	
	Croup ...	2	2	...	1	...	5	
	Whooping-cough ...	16	2	2	2	13	35	
	Erysipelas ...	2	2	...	2	2	8	
	Diarrhoea ...	49	6	9	13	16	93	
	Other Zymotic Diseases	1	1	2	
	ORDER 2.							
	Syphilis ...	6	3	3	2	1	15	
	ORDER 3.							
	Privation ...	10	...	2	4	...	16	
	Want of Breast-milk ...	4	4	
ORDER 4.								
Thrush ...	3	1	...	4		
II.—CONSTITUTIONAL DISEASES.	ORDER 1.							
	Dropsy...	1	1	2	
	ORDER 2.							
	Scrofula ...	4	2	1	...	1	8	
	Tabes Mesenterica ...	13	2	1	4	12	32	
Phthisis ...	1	1		
Hydrocephalus ...	4	1	5		
Carried forward ...	117	21	21	33	52	244		

TABLE IX.—CONTINUED.

DEATHS OF CHILDREN UNDER ONE YEAR OF AGE DURING THE 52 WEEKS ENDED 30TH DECEMBER, 1882.

CLASS.	CAUSE OF DEATH.	Westgate.	St. Andrew's.	St. Nicholas'.	All Saints'.	Byker.	Total in City.
III.—LOCAL DISEASES.	Brought forward	117	21	21	33	52	244
	ORDER 1.					1	1
	Epilepsy	45	13	10	35	19	122
	Convulsions	7	2	1	4	8	22
	Brain Disease, etc.						
	ORDER 2.						1
	Heart Disease, etc.	1					1
	ORDER 3.					1	1
	Laryngitis	25	7	7	16	20	75
	Bronchitis	5	2		5	7	19
	Pneumonia	2	2		3	2	9
	Lung Disease, etc.						
	ORDER 4.				1		5
	Enteritis	4					1
	Peritonitis	1					5
Stomach Disease, etc.	3	1		1		1	
Hepatitis					1	4	
Jaundice	1					1	
Liver Disease, etc.							
ORDER 5.						1	1
Nephritis			1				1
Kidney Disease, etc.							
ORDER 1.		21	9	6	8	23	67
Premature Birth		1				1	2
Cyanosis		2	2	1	1		6
Spina Bifida		2			1	2	5
Other Malformations		11	1		1	11	24
Teething							
ORDER 2.						1	1
Childbirth (see Puerperal Fever)							
ORDER 4.		86	21	17	43	58	225
Atrophy and Debility							
ORDER 1.—(ACCIDENT OR NEGLIGENCE.)						1	1
Poison						7	6
Suffocation		9	2	1			1
Otherwise							
ORDER 2.—HOMICIDE.							1
Murder and Manslaughter							
ORDER 4.							3
Violent Deaths (not classed)		2	1				1
Sudden Deaths (cause unascertained)						1	
Causes not specified or ill-defined		15	1	1	15	7	39
Representing a rate of 6.1 } per 1,000 per Annum. }	TOTAL ...	360	86	65	176	227	914

TABLE X.

UNCERTIFIED DEATHS IN EACH SUB-DISTRICT DURING THE 52 WEEKS ENDED 30TH DECEMBER, 1882.

ALLEGED CAUSE OF DEATH.	Westgate.		St. Andrew's.		St. Nicholas'.		All Saints'.		Byker.		Total.					
	Under 1 Year.	1 Year and Under 2 Years and Above.	Under 1 Year.	1 Year and Under 2 Years and Above.	Under 1 Year.	1 Year and Under 2 Years and Above.	Under 1 Year.	1 Year and Under 2 Years and Above.	Under 1 Year.	1 Year and Under 2 Years and Above.	Under 1 Year.	1 Year and Under 2 Years and Above.				
Suppressed Scarlet Fever												1				
From the Effects of Scarlet Fever												1				
Diarrhœa	1											2				
Consumption		1										1				
Epilepsy		1										1				
Convulsions	11		1		3		14		4	1		33				
A Convulsion Fit		1										1				
A Fit										1		1				
Paralysis		1										1				
Heart Disease		2		1								1				
Acute Rheumatism } Heart Disease }		1										1				
Bronchitis			1								1	1				
Pneumonia — Ex- } haustion }								1				1				
Dropsy of Abdomen			1									1				
Premature Birth	2		3		4		1			7		17				
Premature Birth } and Debility }			1									1				
Dentition & Diarrhœa	1											1				
Decay		1										1				
Debility	6		1				7		5			19				
Congenital Debility							1					1				
Accidentally Drowned							1					1				
Loss of Blood through the bursting of a vein from an old Ulcer in the Leg				1								1				
Nervous Depression or some other Natural Cause		1										1				
Believed from a Convulsive Fit							3					3				
Believed from a Convulsion							1					1				
Believed from Consumption										1		1				
Believed from Bronchitis							1					1				
Believed from some Natural Cause							1	2				1				
Believed from Exhaustion resulting from Indigestion							1					1				
Abcesses		1										1				
Exhaustion	3						1					4				
Hæmorrhage (Umbilicus)							1					1				
Difficult Labour	1											1				
Some Natural Cause	1	1					2	1	1	1	4	2				
Total	25	3	9	8	2	8	3	33	2	4	17	1	8	91	6	26

TABLE XI.

RETURN OF DEATHS FROM MIASMATIC DISEASES FOR THE 52 WEEKS ENDED 30TH DECEMBER, 1882, CORRECTED BY DISTRIBUTION OF THOSE OCCURRING IN THE FEVER HOSPITAL TO THE REGISTRATION SUB-DISTRICT FROM WHICH EACH CAME.

	Number in City.	REGISTRATION SUB-DISTRICTS.				
		West-gate.*	St. Andrew's	St. Nicholas'	All Saints'	Byker.
Total Miasmatic Deaths	580	220	45	46	102	167
INCLUDING—						
Small-pox	57†	18	8	5	4	22
Measles	14	...	2	1	4	7
Scarlet Fever	82	30	1	7	21	23
Diphtheria	5	2	1	1	...	1
Whooping Cough	107	50	10	6	12	29
Typhus Fever	30	...	2	4	14	10
Enteric Fever	30	4	4	22
Simple Continued Fever	1	1
Diarrhoea	159	79	12	14	25	29
Other Miasmatic Diseases	95	37	9	7	18	24
Annual Rate of Death from Miasmatic Diseases per 1,000 population of each Sub-district	3.9	3.5	2.3	4.6	4.1	5.3
Small-pox	0.3	0.2	0.4	0.5	0.1	0.6
Scarlet Fever	0.5	0.4	0.05	0.7	0.8	0.6
Whooping Cough	0.7	0.7	0.5	0.6	0.4	0.9
Typhus Fever	0.2	0.0	0.1	0.4	0.5	0.3
Enteric Fever	0.2	0.06	0.0	0.0	0.1	0.6

* Excluding Benwell and Fenham

† Two deaths from Small-pox in Hospital, omitted from the Registrar's Return, are not included in this Table.

TABLE XII.

LOCALITY OF DEATHS FROM PREVALENT ZYMOTIC DISEASES, CORRECTED BY DISTRIBUTION OF THOSE OCCURRING IN THE FEVER HOSPITAL TO THE SUB-DISTRICT FROM WHICH EACH CAME.

LOCALITY.	DEATHS IN WESTGATE SUB-DISTRICT.														
	SMALL-POX.				SCARLET FEVER.				WHOOPIING COUGH.				AUTUMNAL DIARRHOEA.		
	1st Quarter.	2nd Quarter.	3rd Quarter.	4th Quarter.	1st Quarter.	2nd Quarter.	3rd Quarter.	4th Quarter.	1st Quarter.	2nd Quarter.	3rd Quarter.	4th Quarter.	During 13 Weeks ended 30th Sept., 1882.	Under 1 Year & under 2.	All Age.
Duke street	1
Buckingham street	1	2	1	1	...	1
Vale street	1
Blandford street	1	5	1	...	2	...	2	...	2
Back Marlboro' street	1
Clumber street	1
Hawes street	1	...	3
Derby street	1	1	...	1	...
Stanhope street	1
Elswick East terrace	1	1	...	1
Summerhill terrace	1
Westmorland street	2
Hull street	1
Back Edward street	1
Edward street	1	1	1	...	1	...
Mill lane	1	1	1	...	1	...
Marsden street	2
Bell street	1	2	...	2	...
Victoria street	1
Rye hill	1	1
Tulloch street	1	1	...	1	...
Noble street	1
Stone street	2	...	1
Elswick street	1	1	...	1	...
Pitt street	1	1	...	2	...
Panmure street	1
Pine street	1
George street	1	...	2	...	2	2	1	...	2	...
Spring Garden lane	5
Gloucester road	1	2	2	2	...
Railway terrace	2	1
Wellington street	1	1	...	1	...
Scotswood road	2
Cromwell street	1
High Cromwell street	1
Hindhaugh street	2
Mill yard, Gallowgate	1
Hill street	2
Blenheim street	1	...	2	...	2	...	1
Meldon street	1
Thornton street	1
Park road	1	...	1	...
Workhouse	1	1	1	6	...
Carried forward	2	9	6	8	6	3	21	24	1	3	13	3	24

TABLE XII.—CONTINUED.

LOCALITY OF DEATHS FROM PREVALENT ZYMOTIC DISEASES, CORRECTED BY DISTRIBUTION OF THOSE IN THE FEVER HOSPITAL.

DEATHS IN WESTGATE SUB-DISTRICT.—Continued.															
LOCALITY.	SMALL-POX.				SCARLET FEVER.				WHOOPIING COUGH.				AUTUMNAL DIARRHŒA.		
	1st Quarter.	2nd Quarter.	3rd Quarter.	4th Quarter.	1st Quarter.	2nd Quarter.	3rd Quarter.	4th Quarter.	1st Quarter.	2nd Quarter.	3rd Quarter.	4th Quarter.	During 13 Weeks ended 30th Sept., 1882.		
													Under 1 Year.	1 Year & under 2.	All Ages.
Brought forward...			2	9	6	8	6	3	21	24	1	3	13	3	24
Bath lane terrace			1										2		2
Herbert street															1
Bentinck street														1	1
Cottenham street													1		1
Pit lane													1		1
Centre street													2		2
William street													1		1
Crispin street													1		1
Bowman street													1		1
Portland street													1		1
Churchill cottages				1									1		1
Elswick Colliery yard													1		1
Lord street													1		1
Beaconsfield street								1					1		1
West street													1		1
Bayley street													1		1
Worley street													1		1
New Mills													2		2
Maple street													1		1
Back Panmure street..													1		1
Oystershell lane													1		1
Dunn street													1		1
Jefferson street							1						1		1
Westgate road													2		2
Barrack road													1		1
Mitford street				1									1		1
Brunel terrace													1		1
Nellis' court, Seaham st													1		1
Bell terrace								1					1		2
Diana street													1		1
Westmorland lane													1		1
De Grey street															
Spring street															
St. Anne's convent, } Summerhill grove }													1		
Maiden street				1											
Penn street				1											
Seaham street				1											
Sunderland street				1											
Kyle place				1											
Total ...			3	16	6	8	8	8	21	24	2	3	40	6	57

TABLE XII.—CONTINUED.

LOCALITY OF DEATHS FROM PREVALENT ZYMOTIC DISEASES, CORRECTED BY DISTRIBUTION OF THOSE IN THE FEVER HOSPITAL.

DEATHS IN ST. ANDREW'S SUB-DISTRICT.																			
LOCALITY.	SMALL-POX.				SCARLET FEVER.				WHOOPIING COUGH.				AUTUMNAL DIARRHŒA.						
	1st Quarter.	2nd Quarter.	3rd Quarter.	4th Quarter.	1st Quarter.	2nd Quarter.	3rd Quarter.	4th Quarter.	1st Quarter.	2nd Quarter.	3rd Quarter.	4th Quarter.	During 13 Weeks ended 30th Sept., 1882.						
													Under 1 Year.	1 Year & under 2.	All Ages.				
Carloli street				1															
Park place													1	1					
Percy street													1	2					
Spital tongues													1						
Prudhoe place													1						
Liverpool street										1			1						
Princess street													1						
Patterson's court													1		1				
Percy court													1		1				
Pace's Buildings, } Back lane }				1										1	1				
Newgate street															1				
Mackford's entry														1	1				
Nelson street														1	1				
High Friar street														1	1				
Fleece court													1		1				
Sandyford square														1	1				
George place, Percy st.														1	1				
Sandyford road																			
Grey Horse Inn, Gal- } lowgate }				1															
Factory yard													1						
Dispensary lane													1						
Worthy's yard													1						
Clayton street													1						
Total				1	7					1			2	7	1	3	6	10	
DEATHS IN ST. NICHOLAS' SUB-DISTRICT.																			
Stowell street				1									1			1	1	3	
Forth terrace													1						
St. Nicholas' churchyd.													1						
Steel's yard, 41, Close													1						
Flying Horse inn, } Groat market }													1						
Trotter's entry, Close													1						
Groves' entry, Close													1						
Chambers' court, } Newgate street }													1						
Low Friar street														1					
Dog Leap terrace																2		2	
Carried forward...				1									4	1			3	1	5

TABLE XII.—CONTINUED.

LOCALITY OF DEATHS FROM PREVALENT ZYMOTIC DISEASES, CORRECTED BY DISTRIBUTION OF THOSE IN THE FEVER HOSPITAL.

DEATHS IN ST. NICHOLAS' SUB-DISTRICT.—Continued.															
LOCALITY.	SMALL-POX.				SCARLET FEVER.				WHOOPIING COUGH.				AUTUMNAL DIARRHŒA.		
	1st Quarter.	2nd Quarter.	3rd Quarter.	4th Quarter.	1st Quarter.	2nd Quarter.	3rd Quarter.	4th Quarter.	1st Quarter.	2nd Quarter.	3rd Quarter.	4th Quarter.	During 13 Weeks ended 30th Sept., 1882.		
													Under 1 Year.	All Ages.	
Brought forward...	1	...	5	4	1	3	1	5
Westgate road	1
Black Bull entry, Forth Banks	1	...	1
Shanks' yard, High Bridge	1	...	1
Back row	1	...	1
Forth street	1	...	1
Bankside, Castle garth	1
Waller's yard, Forth Banks	1
Haywood's court, Cloth market	1
Kinghorn's yard, Long stairs	1
Monk square	1
Stowell square	2	1
Total	3	4	5	1	1	4	1	1	6	2	9
DEATHS IN ALL SAINTS' SUB-DISTRICT.															
New road	1
Turner street	1
Stepney lane	1	1
Albert street	1	1	...	1
Silver street	1	1
Shield street	1
Meeting house lane, Silver street	1
Stoddart street	2	1
Clarence crescent	1	1
Pilgrim street	1	1
Victoria terrace	1
Keelmen's Hospital, New road	2
Russell terrace	1	1
Howard street	1	...	1
Brewery bank, Quaysd.	1
White Boar entry, St. Ann's street	1	...	1
Victoria place	1	...	1
Carried forward...	2	4	2	2	1	5	4	...	4	...	6

TABLE XII.—CONTINUED.

LOCALITY OF DEATHS FROM PREVALENT ZYMOTIC DISEASES, CORRECTED BY DISTRIBUTION OF THOSE IN THE FEVER HOSPITAL.

DEATHS IN ALL SAINTS' SUB-DISTRICT.—Continued.															
LOCALITY.	SMALL-POX.				SCARLET FEVER.				WHOOPIING COUGH.				AUTUMNAL DIARRHŒA.		
	1st Quarter.	2nd Quarter.	3rd Quarter.	4th Quarter.	1st Quarter.	2nd Quarter.	3rd Quarter.	4th Quarter.	1st Quarter.	2nd Quarter.	3rd Quarter.	4th Quarter.	During 13 Weeks ended 30th Sept., 1882.		
													Under 1 Year.	All Ages.	
Brought forward...	2	4	2	2	1	5	4	...	4	...	6
Ridley villas	1	...	1
Ouse street	1
Pandon	1	1
Chapel buildings, Buxton street	1	...	1
Hewitt's court, Pilgrim street	1
Buxton street	1	1
Painter heugh	1	1
Stepney terrace	1	1
Henry street	1	...	1
Kent street	1	...	1
Picton terrace	1
Gosforth street	1	1
Low bridge	1	...	1
Carlton street	1	1	1	...	1
Ridley street	1	...	1
Industrial dwellings, Garth heads	1	1	1
Wesley street	1
Copland terrace	1
New Bridge street	1
Shieldfield green	2
Gibson street	2
Cowgate	1
Total	1	2	2	4	5	10	1	5	6	...	10	5	19
DEATHS IN BYKER SUB-DISTRICT.															
Brough's buildings	1	1
Shields road	1	...	1
Burton street	1	1
Cook street	1
Thornborough street...	1	...	1	1	3
Raby street	1
Molyneux street	1	1	...	1	...	1	...	1
Parker street	1	1	2	3
Carried forward...	3	1	1	1	8	3	2	...	1	2	4

TABLE XII.—CONTINUED.

LOCALITY OF DEATHS FROM PREVALENT ZYMOTIC DISEASES, CORRECTED BY DISTRIBUTION OF THOSE IN THE FEVER HOSPITAL.

DEATHS IN BYKER SUB-DISTRICT.—Continued.															
LOCALITY.	SMALL-POX.				SCARLET FEVER.				WHOOPIING COUGH.				AUTUMNAL DIARRHŒA.		
	1st Quarter.	2nd Quarter.	3rd Quarter.	4th Quarter.	1st Quarter.	2nd Quarter.	3rd Quarter.	4th Quarter.	1st Quarter.	2nd Quarter.	3rd Quarter.	4th Quarter.	During 13 Weeks ended 30th Sept., 1882.		
													Under 1 Year.	1 Year & under 2.	All Ages.
Brought forward...	3	1	1	1	8	3	2	...	1	2	4
Clifford street	2
Shipley street	2	...	1	1	1	2
Byker street	1
Fernwood road	1
Byker bank	1	1	...	1
St. Peter's	1	...	2	1	1	...	1
Malcolm street	1	2
Byker village	1
Tynemouth road	1
St. Anthony's	3	1	3
Rosdale street	1
Dunn's terrace	1	1	...	1
Corbridge street	3	1	...	1	...	1
Quality row	1	...	1	...	1
Catterick's buildings...	1
Appleton's buildings...	1	...	1
Salisbury street	1	...	1	...	1
North view	1	1	...	1
Stepney street	1	1	...	1
Brandling village	2
Morrison street	1
Mawson street	1	...	1
Clayton Park square...	1	1	1
Maling street	1	1
Stoddart street	1	1
Turner street	2
Conyer's road	...	2	4	1
Harvey street	1	1	...	1
Miller's lane	1
Crawford's row	1	...	1
Langhorn street	1	...	1
Northern Counties } Institution for Deaf and Dumb	1
Walker road	1
Jesmond vale	1
James' place	1
Wilfred street	1
Norfolk road	1
Total	...	2	15	5	4	4	5	10	12	8	7	2	10	7	23

SUMMARY OF TABLE XII.

REGISTRATION SUB-DISTRICTS.	SMALL-POX.				SCARLET FEVER.				WHOOPIING COUGH.				AUTUMNAL DIARRHŒA.		
	1st Quarter.	2nd Quarter.	3rd Quarter.	4th Quarter.	1st Quarter.	2nd Quarter.	3rd Quarter.	4th Quarter.	1st Quarter.	2nd Quarter.	3rd Quarter.	4th Quarter.	During 13 Week ended 30th Sept., 1881.		
													Under One Year.	One Year and under Two Years.	All Ages.
Westgate	4	15	6	8	8	8	21	24	2	3	40	6	57
St. Andrew's	1	7	1	...	2	7	1	...	3	6	10
St. Nicholas'	3	4	5	...	1	1	4	1	1	...	6	2	9
All Saints'	1	2	2	4	5	10	1	5	6	...	10	5	19
Byker	...	2	15	5	4	4	5	10	12	8	7	2	10	7	23
Grand Total } of Deaths }	...	2	24	33	17	16	20	29	40	45	17	5	69	26	118

TABLE XIII.

ADMISSIONS TO AND DEATHS AT THE NEWCASTLE FEVER AND SMALL-POX HOSPITALS FROM 1ST JANUARY TO 31ST DECEMBER, 1882.

DISEASES.	ADMISSIONS.												DEATHS.											
	Jan.	Feb.	Mar.	April	May	June	July	Aug.	Sept.	Oct.	Nov.	Dec.	Total	Mar.	May	June	July	Aug.	Sept.	Oct.	Nov.	Dec.	Total	
Small-pox*				2	4	27	26	53	48	51	30	241	2	1	4	3	5	7	12	3	37			
Scarlet Fever		1										1												
Diphtheria		1										1												
Typhus	1		1			5	5	6	18	26	35	98	1			1	1	1	3	5	6	18		
Enteric Fever		3	9	1	1			1	1	1	1	18												
Febricula												1												
Febricula and Pneumonia					1							1												
Chicken-pox		1										2												
Measles					1							1												
Syphilis							1	1				2												
Broncho-Pneumonia									1			1										1		
Pneumonia		1										1										2		
TOTAL	1	6	11	1	4	6	32	33	63	70	78	66	371	1	2	1	5	4	7	10	17	9	56	

* The state of the Small-pox patients as to Vaccination is shown in Appendix B, page 64.

TABLE XIV. (A.)

RETURN OF SUSPECTED AND UNWHOLESOME PROVISIONS EXAMINED DURING 1882.

SUSPECTED PROVISIONS EXAMINED.	Amount.	CONDITION.		BAD—HOW DISPOSED OF.	
		Fit for Food.	Unfit for Food.	Destroyed by Order of Justice.	Destroyed with Consent of Owner.
Carcases of Beef...	201	150	51	5	46
" Veal...	4	1	3	...	3
" Mutton...	132	95	37	...	37
" Pork...	209	75	134	1	133
Sides of Bacon...	4	...	4	4	...
Bacon, Hams...	2	...	2	2	...

Of the 150 carcasses of beef returned as fit for food, 61 of the animals had been bruised more or less during transit. All the bruised portions were cut off and destroyed. Of the 134 carcasses of pork destroyed, 94 were those of foreign swine landed at the Sanatorium, and found to be affected with swine fever whilst there.

Three persons have been summoned before the Magistrates for being the owners of unsound meat intended for human food. Two were fined £10 each and costs, and one case was dismissed.

(Signed) WM. HEDLEY, INSPECTOR.

TABLE XIV. (B.)

RETURN OF FISH RECEIVED IN NEWCASTLE FISH MARKET FROM THE 26TH JUNE, TO 23RD DECEMBER, 1882.

DESCRIPTION.	DELIVERED BY BOAT.					DELIVERED BY RAIL.				
	Baskets.	Barrels.	Boxes.	Bags.	Fish.	Baskets.	Barrels.	Boxes.	Bags.	Fish.
Cod ...	361	34	31	101
Conger ...	7	3
Gurnet ...	11
Haddock ...	2,422	145	1,058	241
Herring	51	149
Ling ...	62	28	31	9	495
Mackerel	678
Salmon	1	17
Trout	7	20
Black Jack...	53	4	16
Whiting ...	124	21
Hake	27
Halibut ...	2	2	2
Plaice ...	91	2	5	54
Skate ...	56	1	5	25
Soles ...	48	1
Turbot	23
Catfish	124
Cockles	25
Mussels	1	134
Crabs	11
Lobsters	10
Shark	1
Whelks	7	...	12	13
Winkles	17
Shrimps	21
Prawns ...	205	2
Findon Haddocks...	...	146	3	3,705
Kippers	60	1,801
Bloaters	48	1,654
Monkfish	88
Total ...	3,442	577	267	13	294	1,148	1,115	7,875	172	12

The inspection of fish at the Close Fish Market was placed under this department in June, by the Sanitary Committee. Since that time no diseased fish has been received there. Several fish have been condemned, being found bad from heat and close packing. They were willingly given up by the owners and destroyed.

(Signed) WILLIAM T. CLARKE,
Chief Inspector of Nuisances and Inspector of Fish

TABLE XV.

INFECTED ARTICLES DESTROYED AND REPLACED BY THE HEALTH DEPARTMENT DURING THE YEAR 1882.

174 Half Straw Mattresses.	2 Feather Beds.
37 Straw Beds.	3 " Bolsters.
9 " Bolsters.	1 " Pillow.
10 " Pillows.	2 Rabbit Down Beds.
13 Bed Ticks.	3 " Bolsters.
6 Bolster Cases.	1 " Pillow.
4 Pillow "	15 Quilts.
43 Flock Beds.	3 Sheets.
21 " Bolsters.	11 Rugs.
36 " Pillows.	1 Blanket.
INFECTED ARTICLES PURIFIED IN THE DISINFECTING APPARATUS.*	
FROM THE CITY.	FROM THE FEVER HOSPITAL.
131 Feather Beds.	29 Beds.
189 Flock "	59 Mattresses.
395 Mattresses.	204 Pillows.
716 Pillows.	3 Bolsters.
297 Bolsters.	63 Bed Ticks.
273 Blankets.	284 Blankets.
310 Quilts.	110 Rugs.
73 Bed Hangings.	140 Quilts.
213 Carpets.	21 Mackintoshes.
641 Articles of Wearing Apparel.	3 Carpets.
475 Miscellaneous Articles.	414 Articles of Wearing Apparel.
	103 Books.
	18 Miscellaneous Articles.

* This list does not show all the work done at the Disinfecting Station. For some months, owing to changes in the staff, the records are incomplete.

TABLE XVI. (A.)

SUMMARY OF CASES DISINFECTED BY THE INSPECTORS OF NUISANCES DURING THE YEAR ENDED 31ST DECEMBER, 1882.

PARISH OR TOWNSHIP.	NATURE OF DISEASE.								TOTAL.
	Small Pox.	Measles.	Scarlet Fever.	Diphtheria.	Typhus Fever.	Enteric or Typhoid Fever.	Continued Fever.	Fever (other varieties).	
Elswick ...	49	...	129	...	2	29	1	1	211
Westgate ...	121	9	68	1	1	12	4	...	216
St. Andrew's ...	28	11	46	...	5	4	1	2	97
St. John's... ..	39	7	13	...	2	5	66
St. Nicholas' ...	17	7	12	1	8	5	1	...	51
All Saints' ...	41	13	85	1	55	36	2	2	235
Jesmond ...	4	1	10	1	...	2	18
Byker ...	110	5	77	1	34	62	...	3	292
Total ...	409	53	440	5	107	155	9	8	1,186

TABLE XVI. (B.)

RETURN OF CASES OF INFECTIOUS DISEASE NOTIFIED BY MEDICAL PRACTITIONERS FROM 29TH SEPTEMBER TO 30TH DECEMBER, 1882.

PARISH OR TOWNSHIP.	NATURE OF DISEASE.							TOTAL.
	Small Pox.	Typhus Fever.	Enteric Fever.	Scarlet Fever.	Continued Fever.	Puerperal Fever.	Diphtheria.	
Elswick ...	46	5	13	88	1	...	1	154
Westgate ...	75	1	11	36	6	1	1	131
St. Andrew's ...	24	3	3	26	1	57
St. John's ...	16	5	1	7	29
St. Nicholas' ...	13	10	3	7	1	34
All Saints' ...	24	51	39	67	4	185
Jesmond ...	4	2	...	29	35
Byker ...	27	22	35	47	2	133
Total ...	229	99	105	307	14	1	3	758

TABLE XVII.—NUISANCE REMOVAL.
SUMMARY OF NUISANCE CASES FOR THE YEAR ENDED 31ST DECEMBER, 1882.

DISTRICTS.	Rooms ordered to be Closed as being unfit for Human Habitation.			Rooms Whitewashed, otherwise Cleaned, and Repaired.			Overcrowding.			Dilapidated Yards and Passages Repaired.			Dirty Yards, Passages, Stairs, cases, &c., Cleaned.			Defective and Badly Constructed Drains, and Sinks.			Branch Drains.			Defective Water Spouts Repaired and Renewed.			Water Supply.			Water-Closets Cleaned and Repaired.			New Water-Closets.			Defective Ash-Closets.			New Ash-Closets.			Privies and Ashpits Altered.			New Privies and Ashpits.			Swine and other Animals Removed.			Offensive Accumulations, &c.			Other Nuisances.			Total.							
	Informal.	Formal.	Total.	Informal.	Formal.	Total.	Informal.	Formal.	Total.	Informal.	Formal.	Total.	Informal.	Formal.	Total.	Informal.	Formal.	Total.	Informal.	Formal.	Total.	Informal.	Formal.	Total.	Informal.	Formal.	Total.	Informal.	Formal.	Total.	Informal.	Formal.	Total.	Informal.	Formal.	Total.	Informal.	Formal.	Total.	Informal.	Formal.	Total.																				
	No. 1	3	3	6	2	5	7	1	1	2	1	1	2	3	3	6	2	3	5	5	5	10	15	20	3	3	6	15	15	30	15	15	30	8	8	16	5	5	10	1	1	2	15	15	30	6	6	12	1	1	2	1	1	2	5	5	10	1	1	2	15	15
No. 2	16	16	32	6	7	13	4	4	8	1	1	2	2	4	5	5	10	3	3	6	1	1	2	2	4	2	2	4	5	5	10	5	5	10	8	8	16	7	7	14	15	15	30	15	15	30	1	1	2	15	15	30	1	1	2	15	15	30				
No. 3	36	36	72	10	10	20	7	7	14	2	2	4	6	6	12	1	1	2	1	1	2	2	4	2	2	4	5	5	10	5	5	10	8	8	16	8	8	16	8	8	16	15	15	30	15	15	30	1	1	2	15	15	30	1	1	2	15	15	30			
No. 4	13	13	26	1	1	2	2	2	4	1	1	2	1	1	2	2	2	2	4	4	4	8	10	10	20	2	2	4	2	2	4	2	2	4	15	15	30	15	15	30	1	1	2	15	15	30	1	1	2	15	15	30										
TOTAL	68	68	136	34	34	68	13	13	26	18	18	36	34	34	68	6	6	12	6	6	12	15	15	30	6	6	12	6	6	12	6	6	12	15	15	30	15	15	30	30	30	60	15	15	30	15	15	30	1	1	2	15	15	30								

Total for the Consumption of Smoke 12

* By informal notices is intended communications made verbally or by letter. Formal notices are those served under the statutes.

TABLE XVIII.
It has not been found necessary to resort to Magisterial Proceedings for enforcing the Abatement of Nuisances on any occasion during the past year.

TABLE XIX.
1882.—RAINFALL, MEAN TEMPERATURE, &c.

1ST QUARTER.			2ND QUARTER.			3RD QUARTER.			4TH QUARTER.		
Week ended.	Rainfall Inches.	Mean Temp. Deg. Fahr.	Week ended.	Rainfall Inches.	Mean Temp. Deg. Fahr.	Week ended.	Rainfall Inches.	Mean Temp. Deg. Fahr.	Week ended.	Rainfall Inches.	Mean Temp. Deg. Fahr.
1882.											
Jan. 7...	0.27	42.3	April 8...	0.12	45.9	July 8...	0.74	59.8	Oct. 7...	0.31	54.5
" 14...	0.08	45.2	" 15...	1.57	41.7	" 15...	0.72	59.9	" 14...	0.83	51.6
" 21...	0.00	43.8	" 22...	0.12	49.8	" 22...	0.67	60.7	" 21...	0.91	50.1
" 28...	0.00	41.3	" 29...	0.81	45.6	" 29...	0.33	59.0	" 28...	0.81	42.3
Feb. 4...	0.36	38.5	May 6...	0.82	49.7	Aug. 5...	0.33	57.8	Nov. 4...	1.07	47.0
" 11...	0.00	44.7	" 13...	0.71	50.4	" 12...	0.00	62.6	" 11...	0.63	42.8
" 18...	0.14	45.4	" 20...	0.00	48.4	" 19...	0.38	61.0	" 18...	0.70	38.8
" 25...	0.00	47.0	" 27...	0.53	54.0	" 26...	1.99	55.6	" 25...	0.52	43.8
March 4...	1.65	42.2	June 3...	0.03	54.5	Sept. 2...	0.58	55.8	Dec. 2...	0.31	36.5
" 11...	0.04	48.3	" 10...	1.21	56.5	" 9...	0.19	55.6	" 9...	2.10	36.0
" 18...	0.00	48.7	" 17...	0.21	50.7	" 16...	0.68	51.2	" 16...	1.44	30.6
" 25...	0.11	42.8	" 24...	1.40	56.6	" 23...	0.18	52.0	" 23...	0.22	41.5
April 1...	0.18	45.9	July 1...	0.47	58.3	" 30...	0.44	52.6	" 30...	0.64	45.5
TOTAL...	2.83	44.3	TOTAL...	8.00	50.9	TOTAL...	7.23	57.2	TOTAL...	10.49	43.1

Total Rainfall during the Year 1882 = 28.55 inches.
Mean Temperature during the Year 1882 = 48.9 deg. Fahr.

APPENDIX B.

SMALL-POX IN RELATION TO VACCINATION.*
 RETURN OF CASES OF SMALL-POX TREATED IN THE NEWCASTLE FEVER AND
 SMALL-POX HOSPITALS DURING 1882.

	Confluent.	Died.	Semi-Confluent.	Died.	Discrete.	Died.	TOTALS.		Mortality per Cent. to cases.
							Cases.	Deaths.	
Not Vaccinated	29	21	27	3	4	...	60	24	40
Doubtful as to Vaccination	1	1	1	...	2	1	50
Vaccination reported, but no Cicatrix	8	3	7	1	4	...	19	4	21
GOOD CICATRICES.									
VACCINATED.	Confluent.	Died.	Semi-Confluent.	Died.	Discrete.	Died.	TOTALS.		Mortality per Cent.
							Cases.	Deaths.	
1 Cicatrix	3	...	8	...	11	...	0
2 Cicatrices	1	...	11	1	24	...	36	1	2.8
3 "	14	...	14	...	0
4 "	15	...	15	...	0
More than 4 Cicatrices	1	1†	3	...	15	...	19	1	5.3†
Total good Cicatrices	2	1	17	1	76	...	95	2	2.1
† A hæmorrhagic case.									
INDIFFERENT OR VERY FAINT CICATRICES.									
VACCINATED.	Confluent.	Died.	Semi-Confluent.	Died.	Discrete.	Died.	TOTALS.		Mortality per Cent.
							Cases.	Deaths.	
1 Cicatrix	4	2	8	1	5	...	17	3	17.6
2 Cicatrices	3	2	7	...	9	...	21	2	9.5
3 "	1	1	2	...	9	...	12	1	8.3
4 "	1	...	6	...	7
More than 4 Cicatrices	1	...	7	...	8
Total—Indifferent or Faint Cicatrices	10	5	19	1	36	...	65	6	9.2
Total—Good Cicatrices	2	1	17	1	76	...	95	2	2.1
Total—Vaccinated	12	6	36	2	112	...	160	8	5.0

* See also observations, page 22.

(H SIDE).

[Property Sketch Book, folio 4.]

IC1

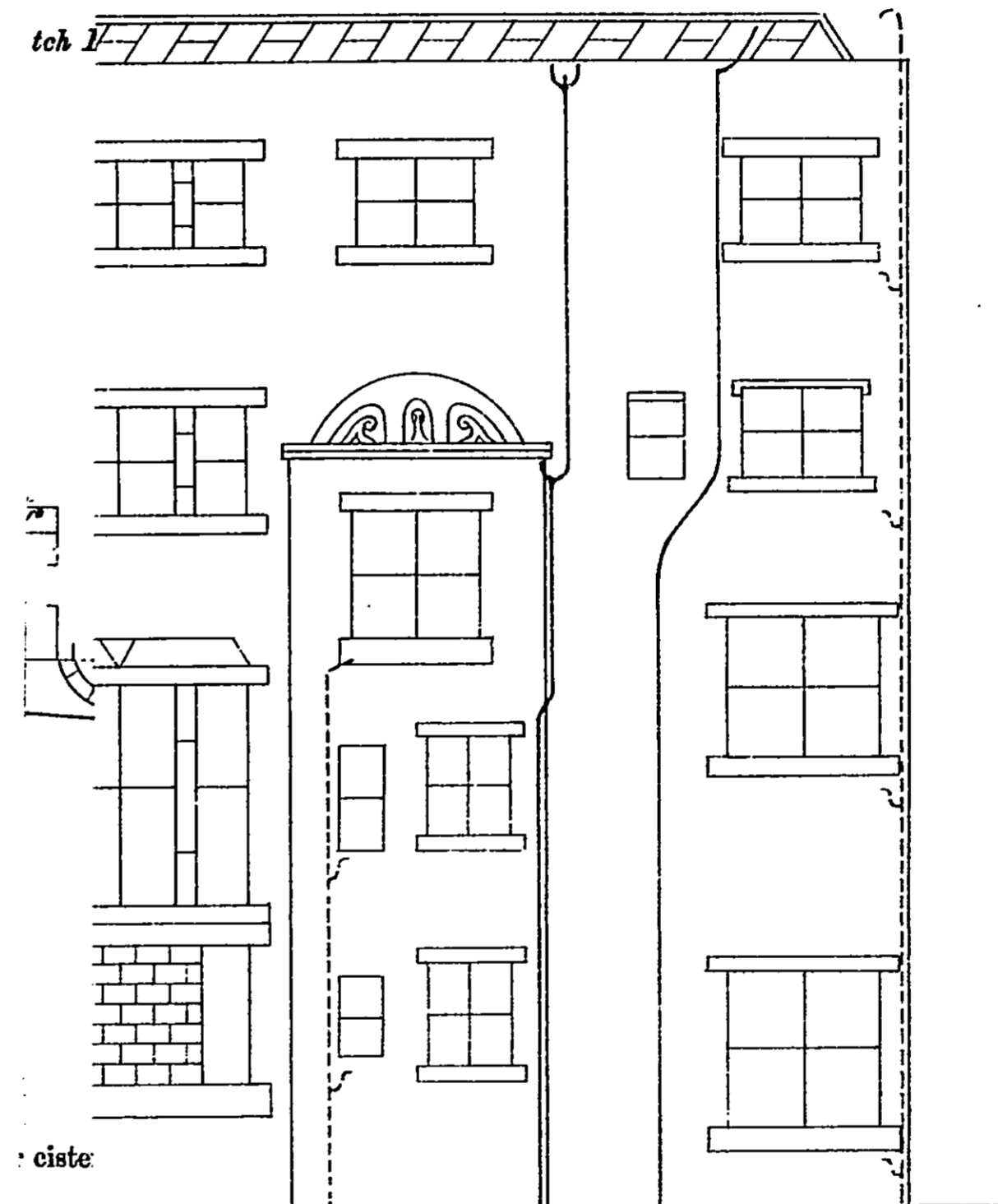

Soil and Bath Pipe inside
 Rain-down Pipe
 Soil pipe Vent
 Sinks connected inside
 in interior
 outside

(APPENDIX C.)

No. —, JESMOND HIGH TERRACE (SOUTH SIDE).

[Property Sketch Book, folio 2.]

HOUSE AS FOUND ON INSPECTION.

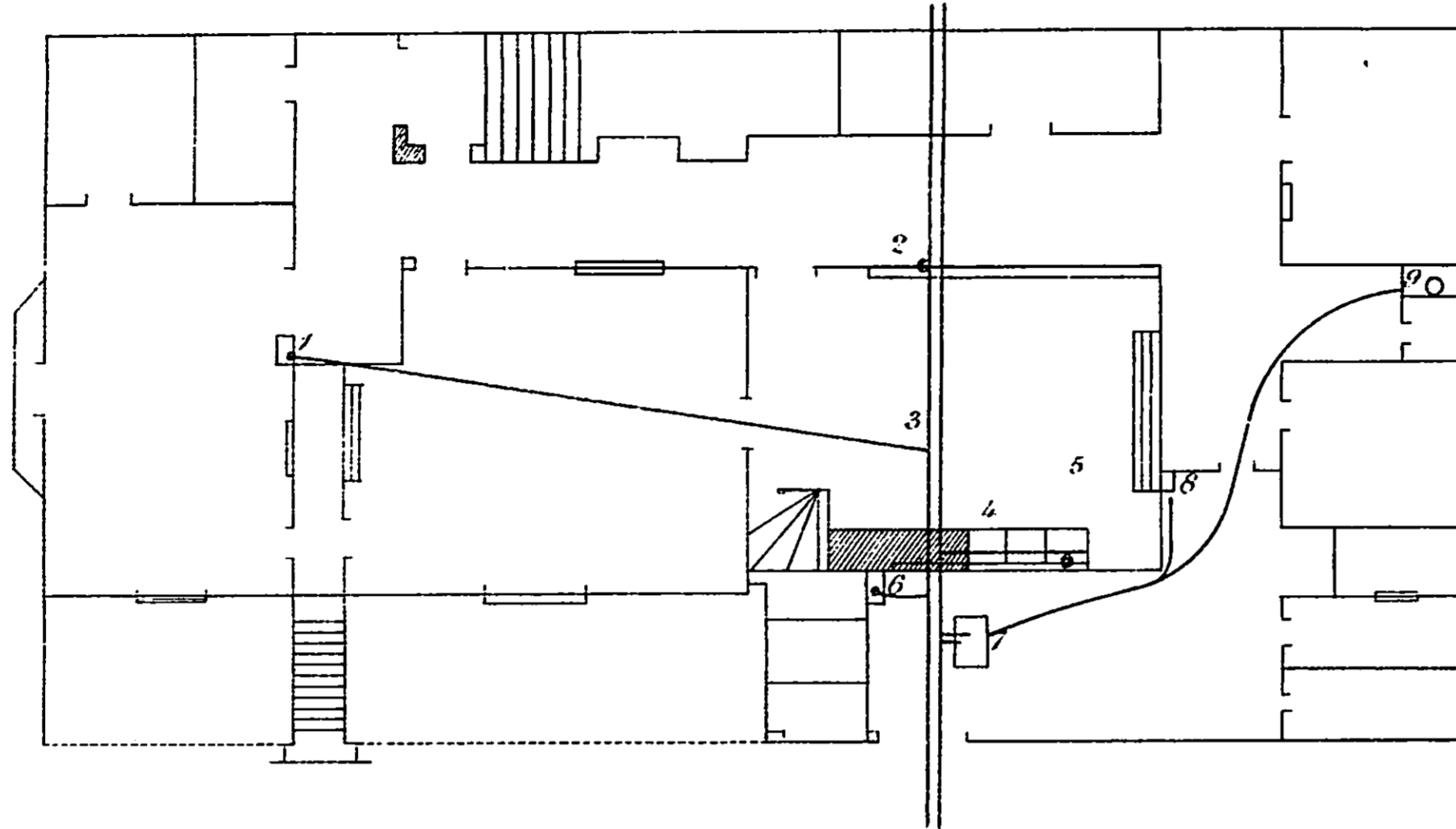

ALTERATIONS.

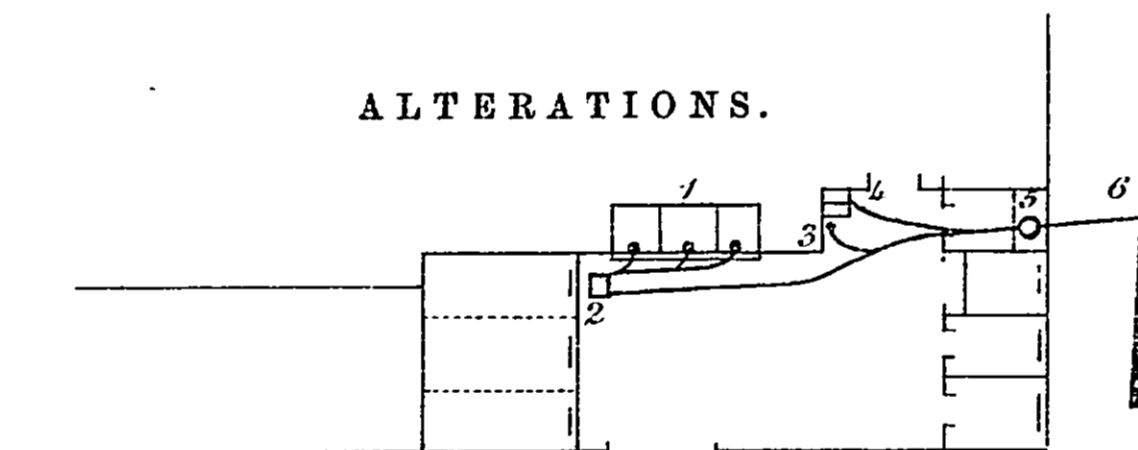

DEFECTS FOUND.

- 1.—Old soil pipe, disused.
- 2.—Soil pipe from existing W.C.
- 3.—Connection of unused drain and old soil pipe with existing drain.
- 4.—Kitchen sinks connected with drain.
- 5.—Manhole under kitchen floor.
- 6.—Iron D trap, on which housemaid's sink and water cistern discharge.
- 7.—Cesspool in yard for the drainage of all the terrace.
- 8.—Iron D trap for surface water.
- 9.—Servants' W.C.

ALTERATIONS.

All the drains, soil pipes, etc., are removed to outside the house, and a drain laid in the yard to the main sewer in back street.

- 1.—Kitchen sinks disconnected and discharging over 2.
- 2.—Gully trap in yard.
- 3.—Soil pipe outside, ventilated to above eaves by full-bore continuation.
- 4.—Gully trap for bath, and lavatory wastes, and rain pipe.
- 5.—Servants' W.C.
- 6.—Connection with main sewer in back street.

No. —, FENWICK TERRACE.

[Property Sketch Book, folio 8.]

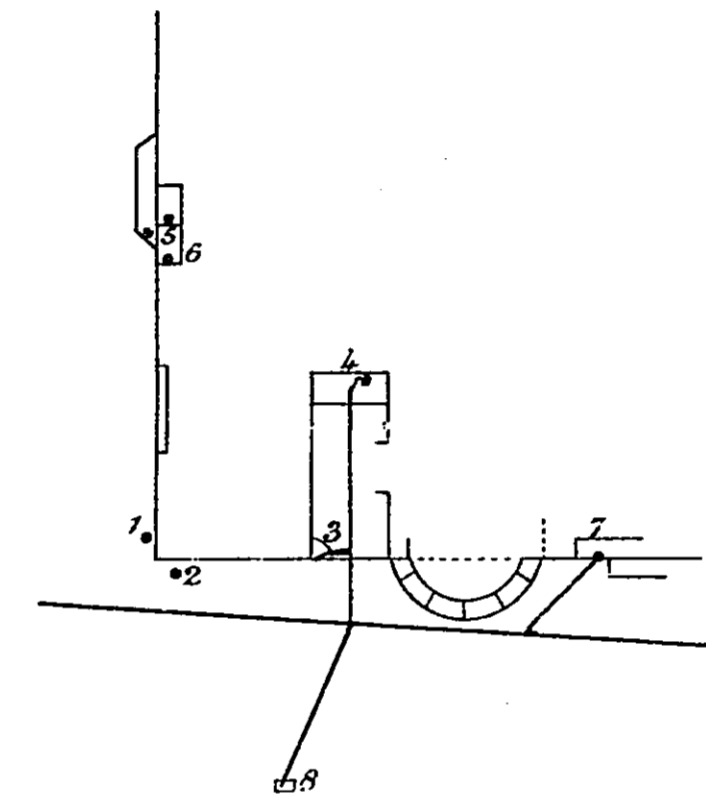

- 1.—Rain-water pipe.
- 2.—Overflow pipe from rain-water cistern.
- 3.—Urinal in W.C.
- 4.—W.C. in interior.
- 5.—Bell trap in area of kitchen window.
- 6.—Kitchen sink.
- 7.—Housemaids' sink.
- 8.—Gully trap in yard.

All connected with drains.

H
1.—
2.—
3.—
4.—
5.—
6.—

No. —, WINDSOR TERRACE (NORTH SIDE).

[Property Sketch Book, folio 10.]

[Property Sketch Book, folio 4.]

WICK TERRACE.

etch Book, folio 8.]

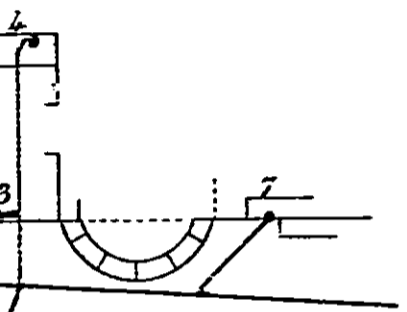

er cistern.
window.
All connected with drains.

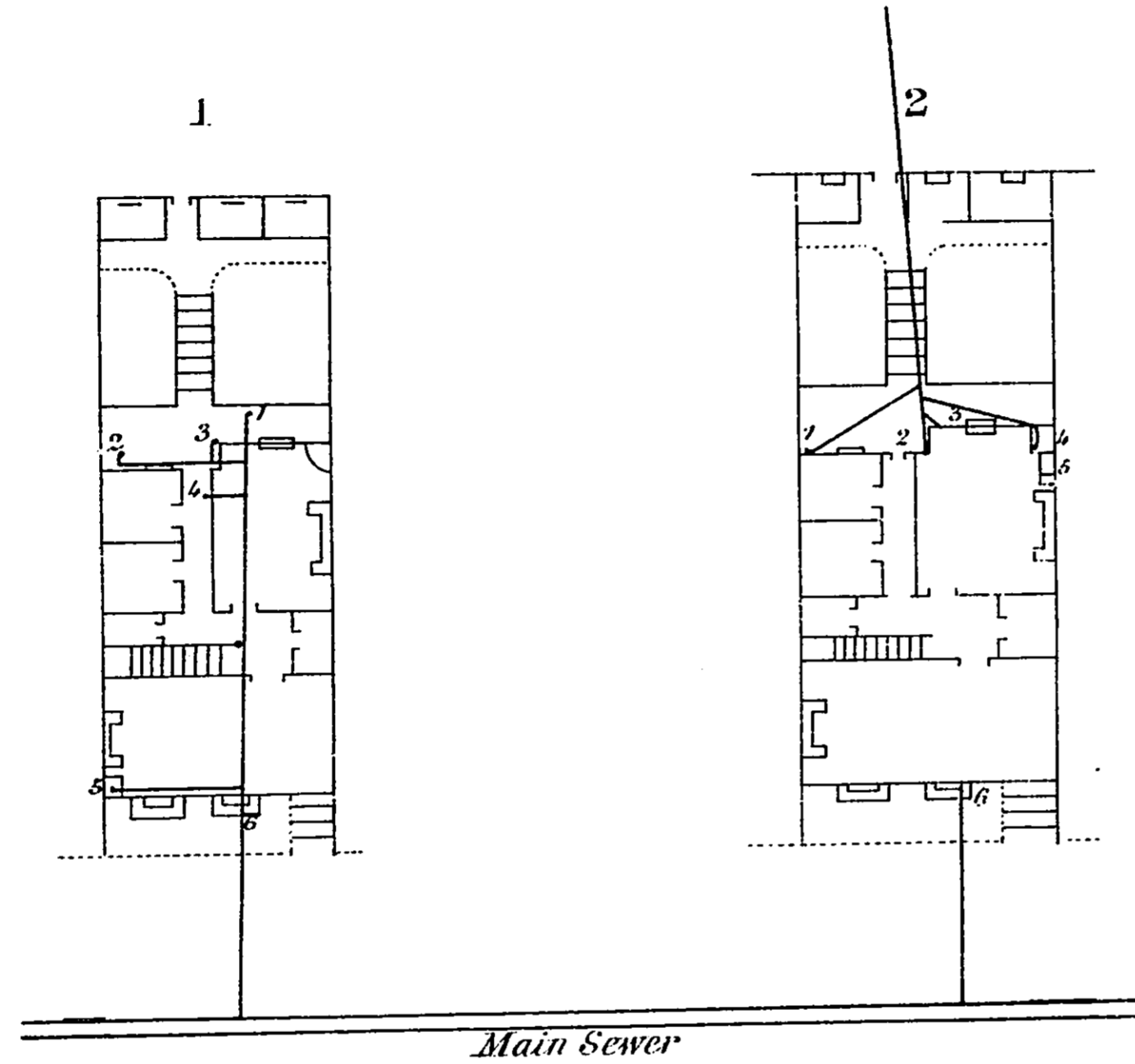

HOUSE AS FOUND ON INSPECTION.

- 1.—Gully trap in yard.
- 2.— Do. do.
- 3.— Do. do.
- 4.—Soil-pipe connection.
- 5.—Kitchen sink.
- 6.—Trap in front area; drain under house back to front.

ALTERATIONS.

- 1.—Gully trap in yard for rain water.
- 2.—Soil pipe connection, ventilated.
- 3.—Gully pipe in yard for bath and cistern waste pipes.
- 4.—Gully trap in yard for scullery sink.
- 5.—Scullery sink, discharges on No. 4.
- 6.—Trap in front area for rain water remains, connected with drain in front. All except No. 6, drain to the back street.



Soil and Bath Pipe inside
Rain down Pipe
Soil pipe Vent
Sinks connected inside

--- Pipes in interior
— D^o outside

CITY & COUNTY OF NEWCASTLE UPON TYNE, 1882.

Fortnightly Diagram of Deaths from principal Zymotic Diseases and Diseases of the Respiratory Organs with Temperature and Rainfall.

(APPENDIX D.)

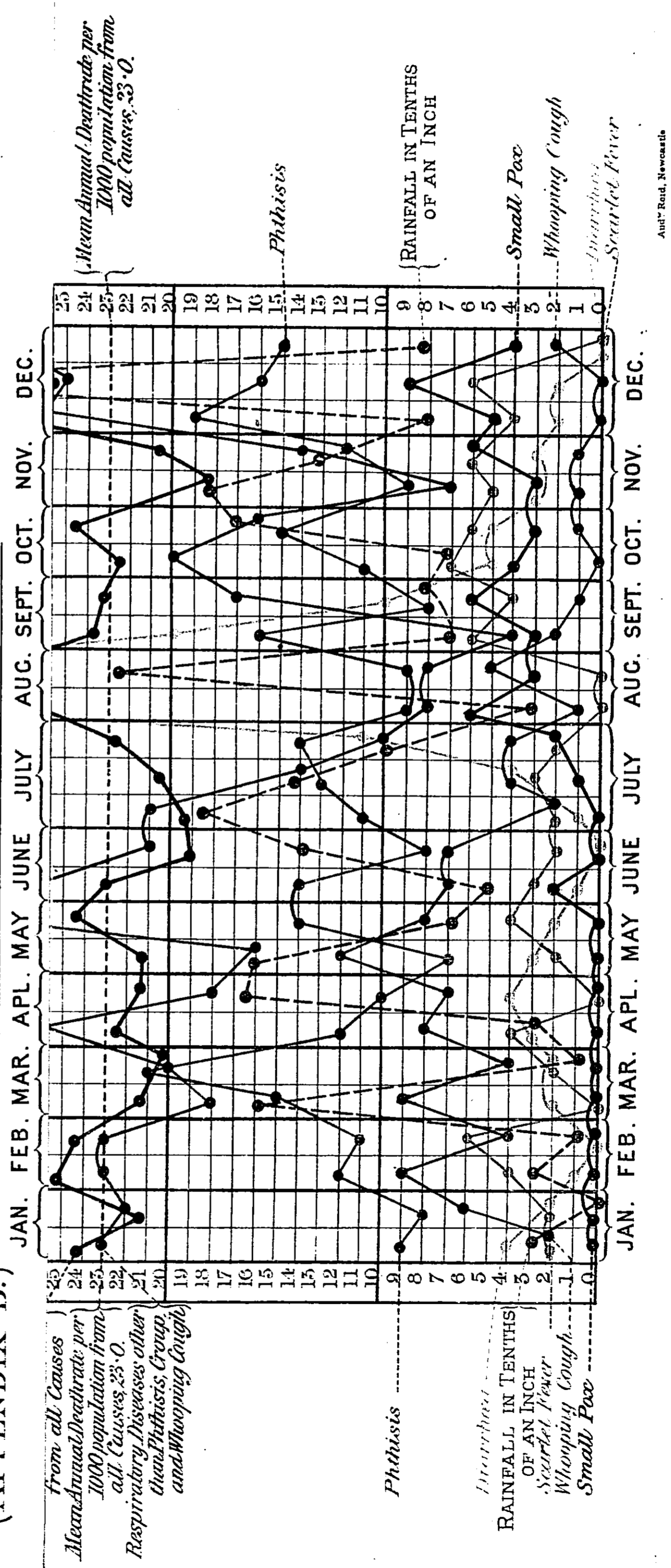

Anti's Road, Newcastle

CITY & COUNTY OF NEWCASTLE UPON TYNE, 1882.

Fortnightly Diagram of Deaths from principal Zymotic Diseases and Diseases of the Respiratory Organs with Temperature and Rainfall.

(APPENDIX D.)

JAN. FEB. MAR. APL. MAY JUNE JULY AUG. SEPT. OCT. NOV. DEC.

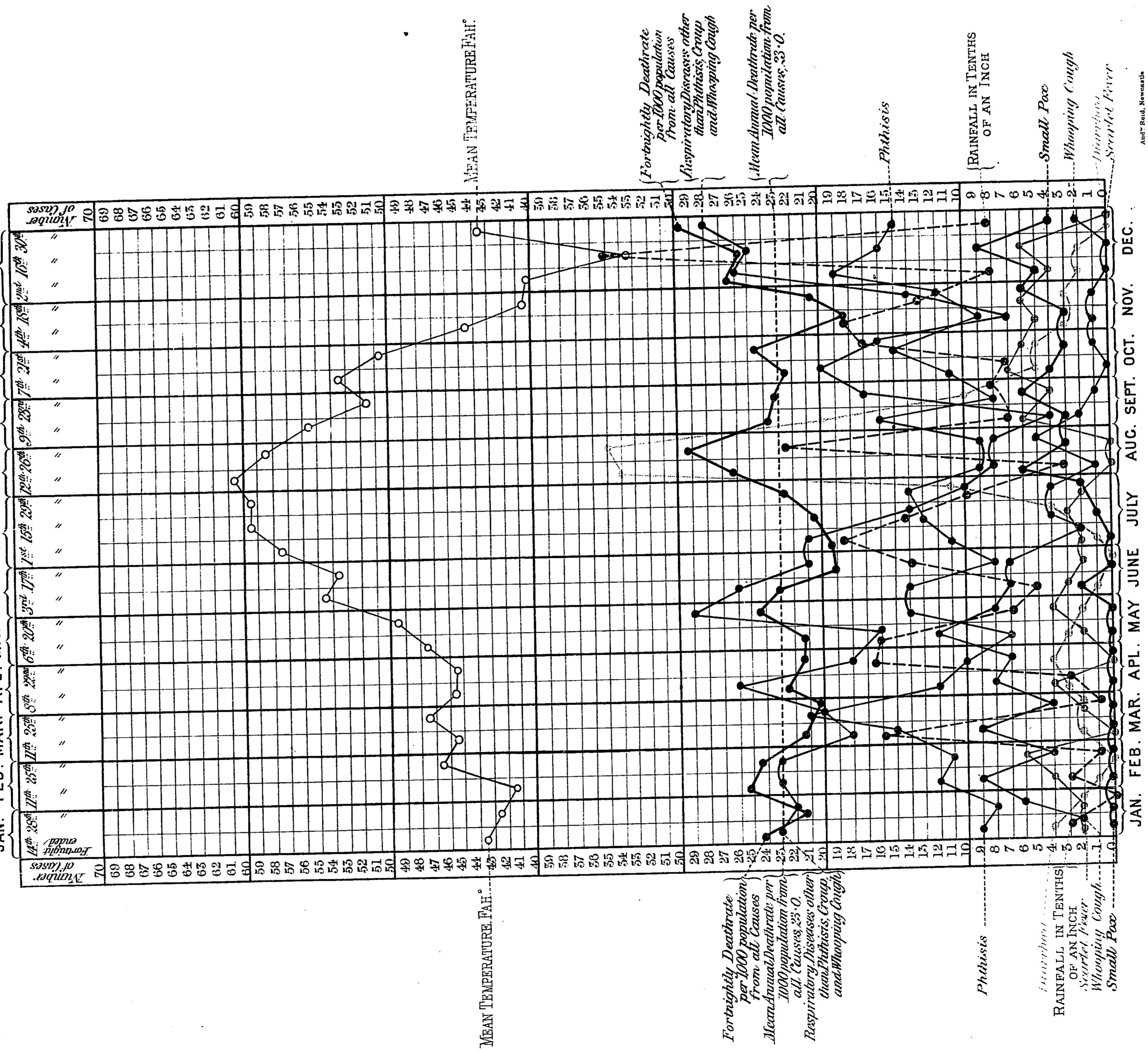

And's Road, Newcastle



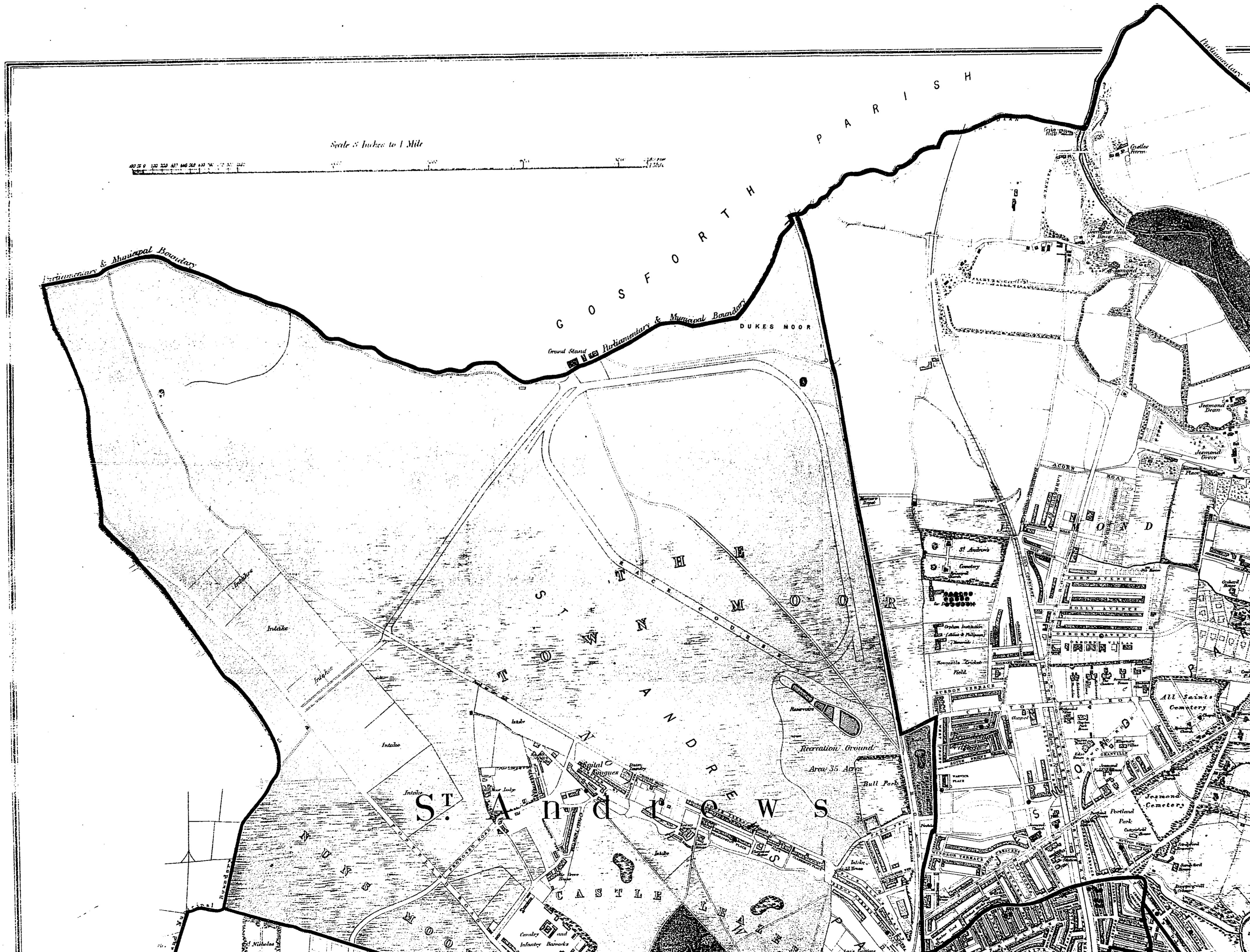

Scale 3 Inches to 1 Mile



G O S F O R T H P A R I S H
DUKES MOOR
Parliamentary & Municipal Boundary

Parliamentary & Municipal Boundary

S T A N D R E W S
F O S T E R
S E A M O N D
R O A D

S T A N D R E W S

C A S T L E L E A Z E S

S E A M O N D

A L L S A I N T S C E M E T E R Y

S E A M O N D C E M E T E R Y

RECREATION GROUND
Area 35 Acres

BULL PARK

Cavalry and Infantry Barracks

St. Nicholas

Castle Farm

Seamond Drain

Seamond Grove

Seamond Park

Seamond Cemetery

Seamond Cemetery

Seamond Cemetery

Seamond Cemetery

Seamond Cemetery

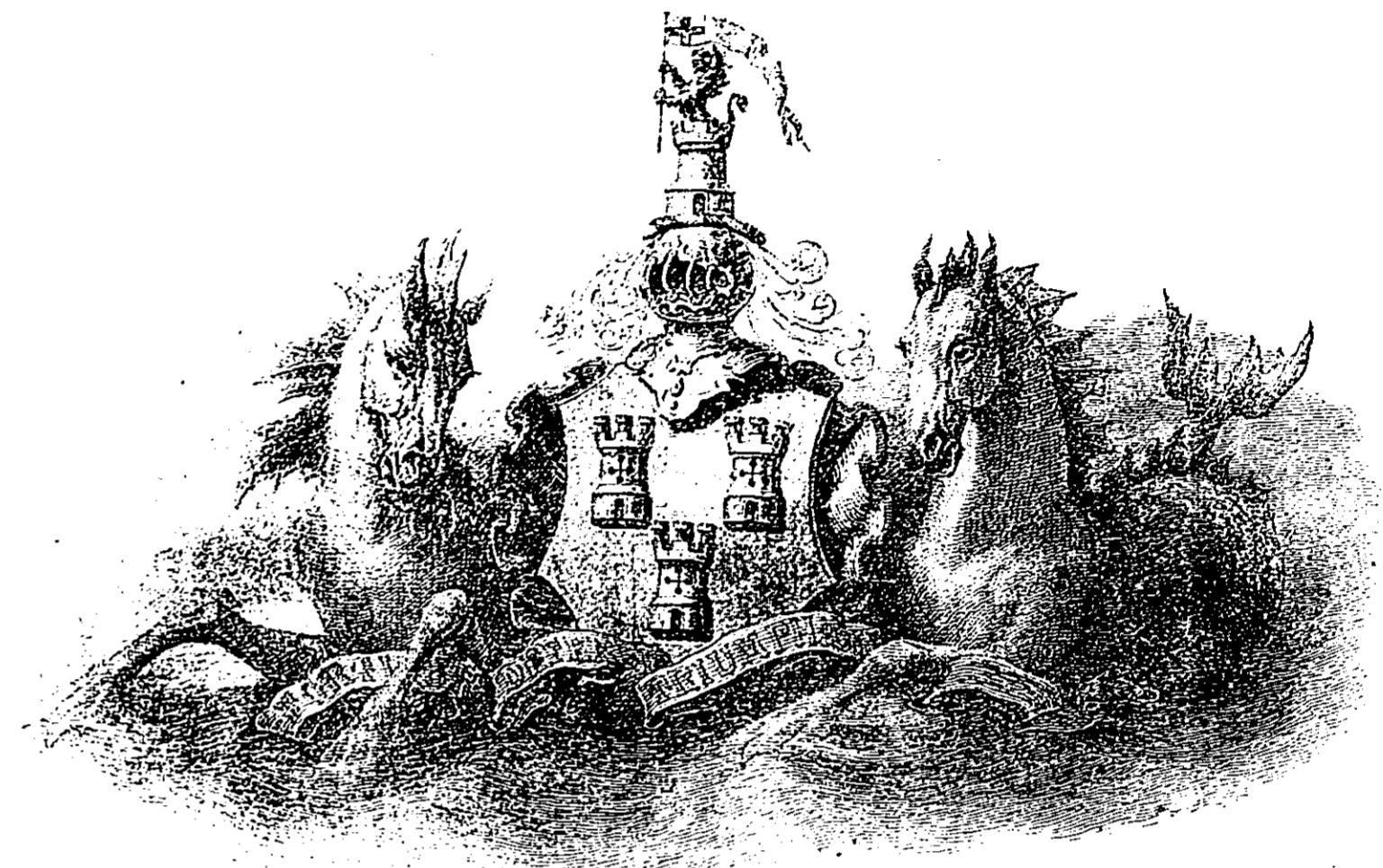

PLAN
 OF THE CITY OF
 NEWCASTLE UPON TYNE.

Reduced from the Actual Survey of the
 CITY ENGINEER

Scale 8 Inches to 1 Mile

1883.

Published by ANDREW REID,
 Printing Court Buildings & 12, Collingwood Street,
 NEWCASTLE UPON TYNE.

EXPLANATION.

EXPLANATION.

- City Boundary.....
- Parish and Township Boundary.....
- County Boundary.....
- Existing Tramways.....
- Proposed Tramways.....

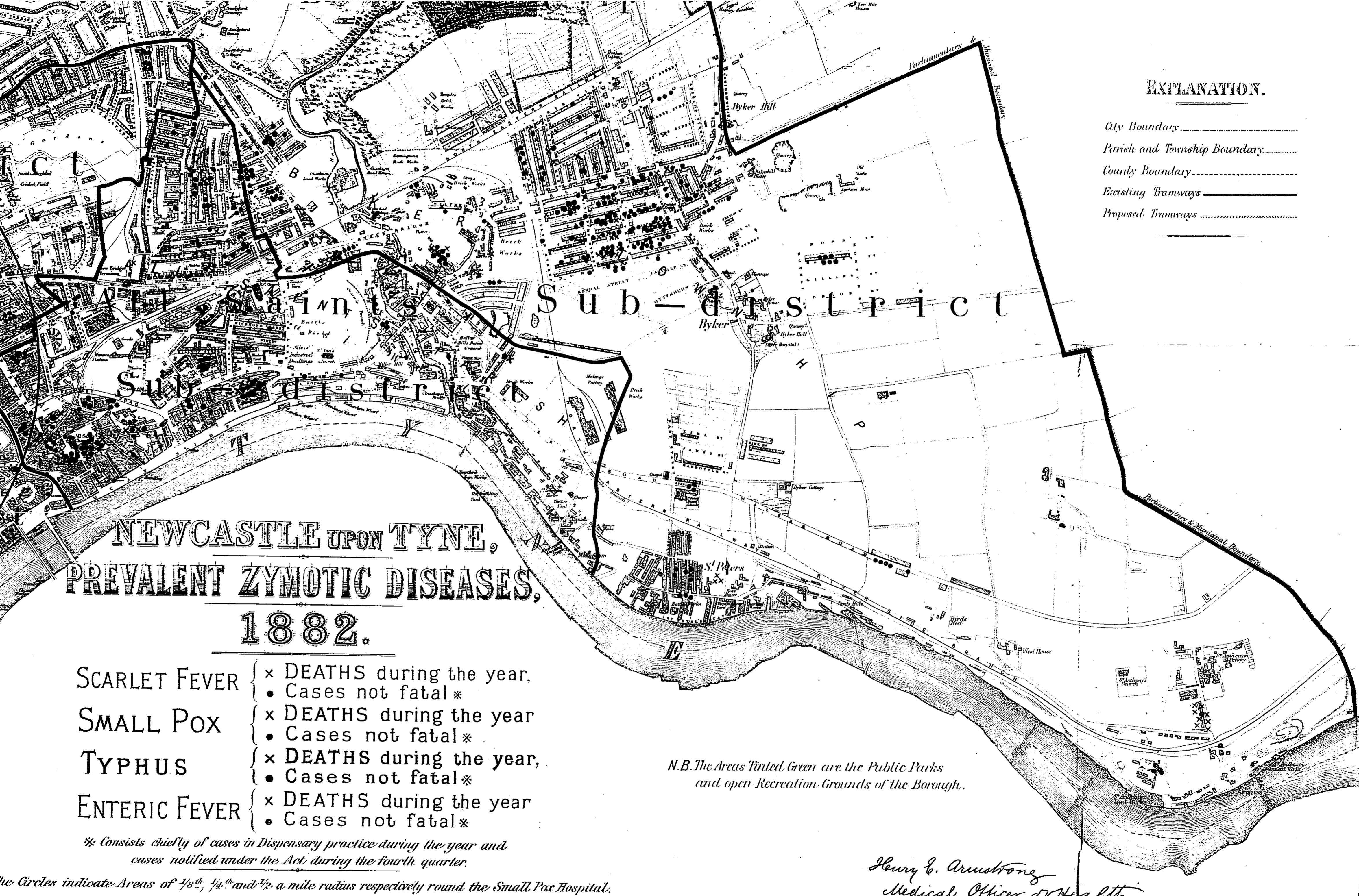

**NEWCASTLE UPON TYNE,
PREVALENT ZYMOTIC DISEASES,
1882.**

- SCARLET FEVER { x DEATHS during the year,
● Cases not fatal*
- SMALL POX { x DEATHS during the year
● Cases not fatal*
- TYPHUS { x DEATHS during the year,
● Cases not fatal*
- ENTERIC FEVER { x DEATHS during the year
● Cases not fatal*

* Consists chiefly of cases in Dispensary practice during the year and cases notified under the Act during the fourth quarter.

The Circles indicate Areas of 1/8th, 1/4th and 1/2 a mile radius respectively round the Small Pox Hospital.

N.B. The Areas Tinted Green are the Public Parks and open Recreation Grounds of the Borough.

Henry G. Armstrong
Medical Officer of Health.



**NEWCASTLE
PREVALENT ZYM
18**

SCARLET FEVER	{	×	D
		•	C
SMALL POX	{	×	D
		•	C
TYPHUS	{	×	D
		•	C
ENTERIC FEVER	{	×	D
		•	C

** Consists chiefly of cases in Dispensary cases notified under the Act*

The Circles indicate Areas of 1/8th, 1/4th and 1/2 a m

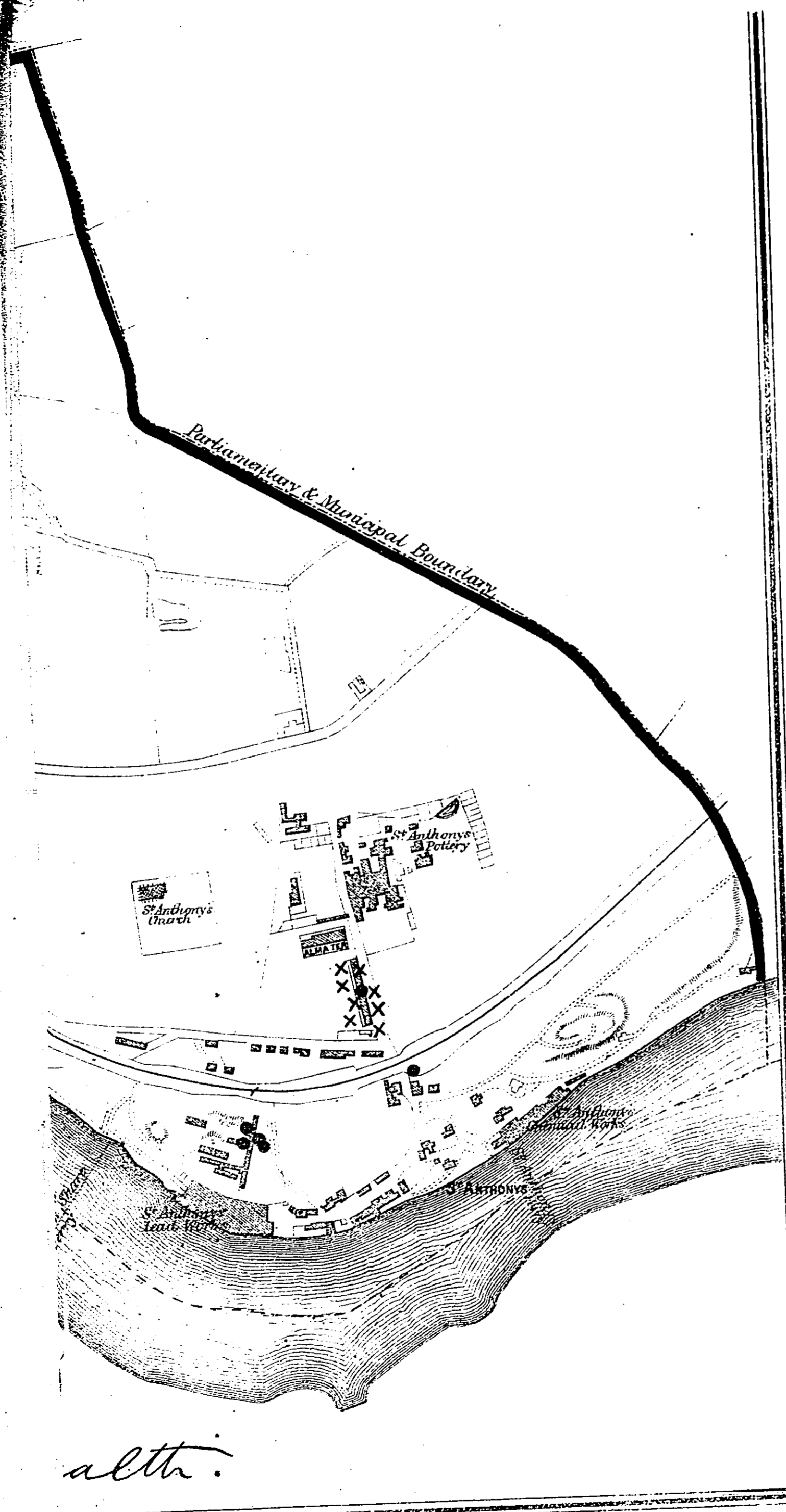

alth.

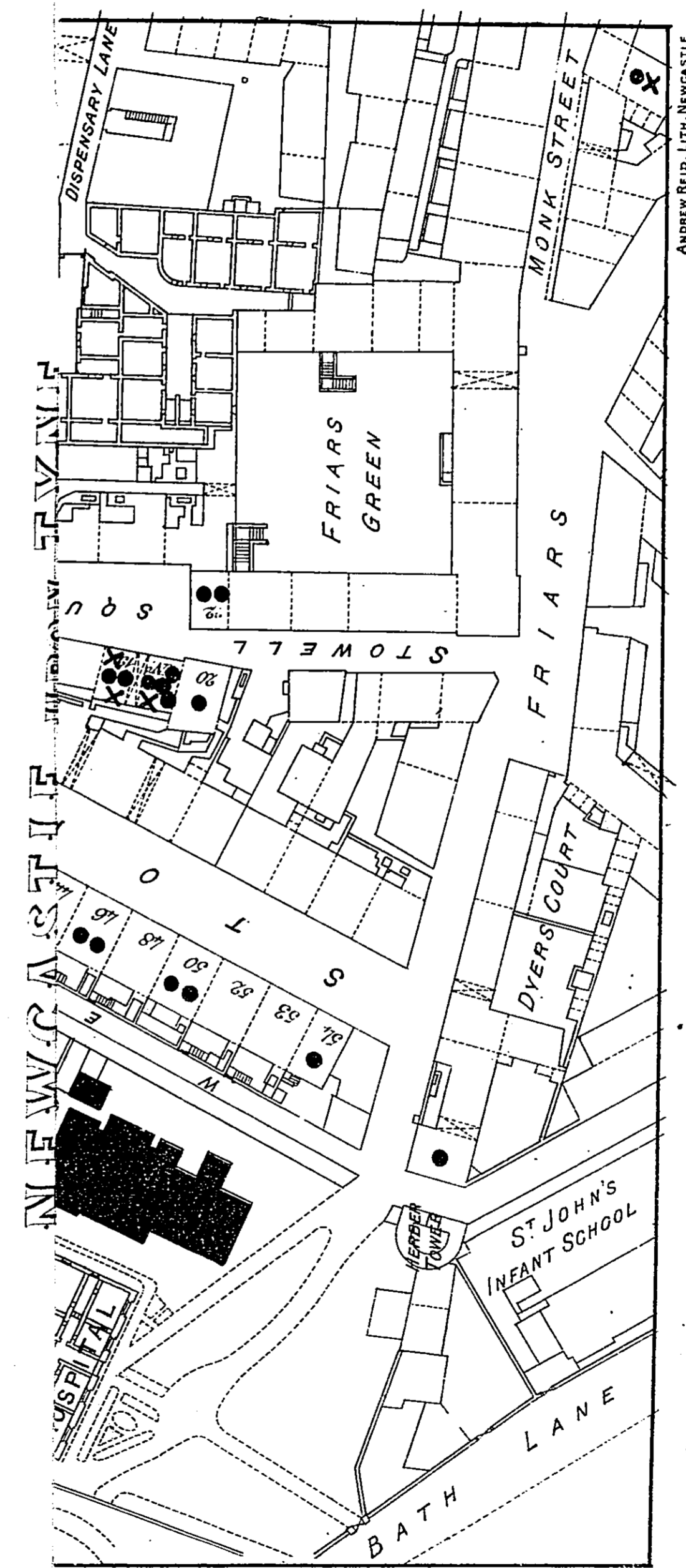

Spread of Small Pox in the vicinity of the Old Small-Pox Wards in 1881,

x Deaths, } with the number of the house.
 • Cases not fatal, }

NEWCASTLE UPON TYNE.

(APPENDIX F.) PLAN OF STOWELL STREET, &c.

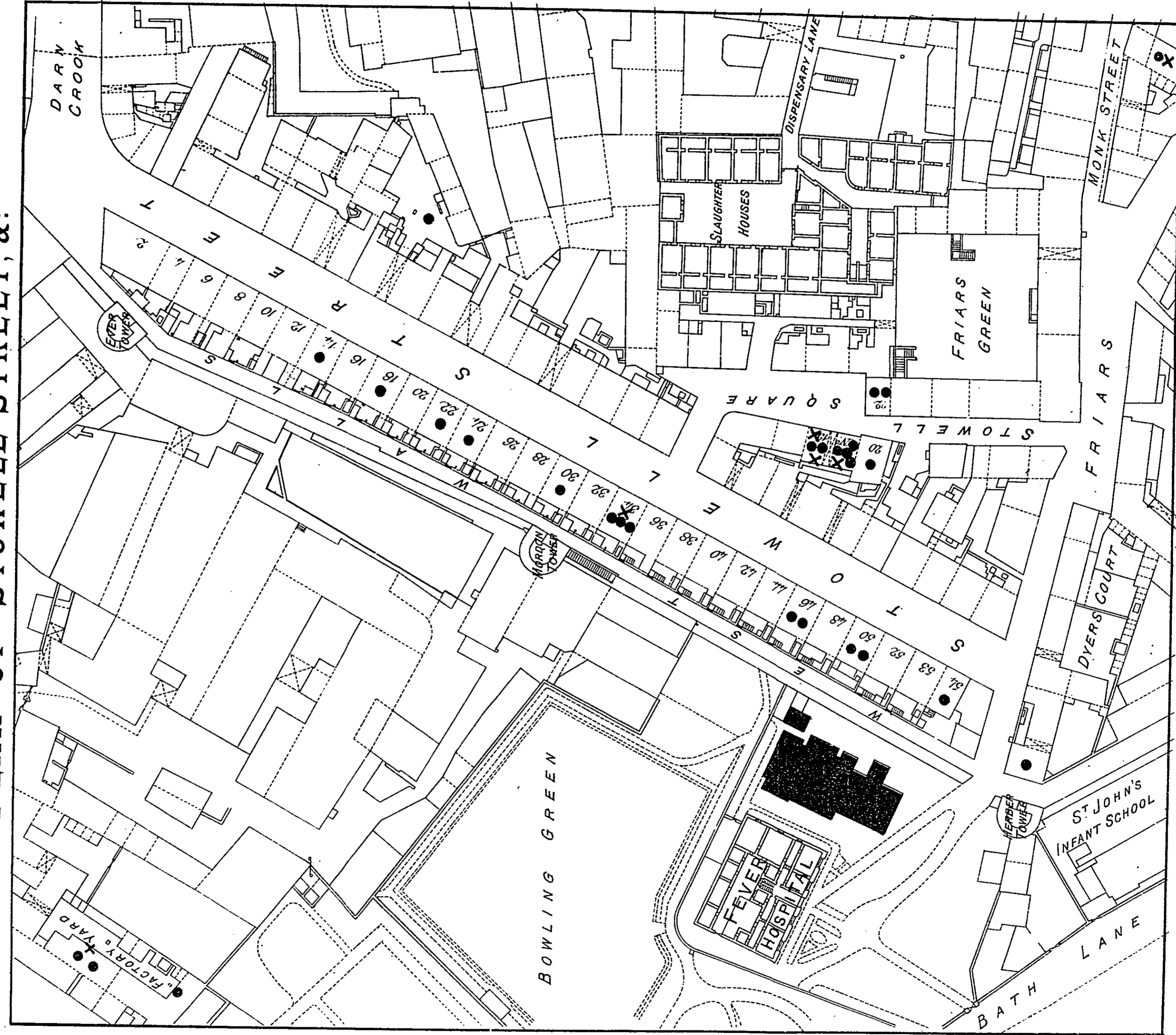

Spread of Small Pox in the vicinity of the Old Small Pox Wards in 1881.

- x Deaths,
 - Cases not fatal,
- } with the number of the house.

ANDREW REID, LITH. NEWCASTLE

E-TO-HO

WATER SUPPLY.

DATE.	Indoor and where situated.	Outdoor and where situated.	Distance from house-door. ved.	Date of service.
1	46	47	48	53

SPECIAL DEFECTS, &c.

54

District No. _____

APPENDIX H. FORM.

CITY AND COUNTY OF NEWCASTLE-UPON-TYNE

DATE.	LOCALITY.	No. of House.	Part of House.	Number of Rooms occupied by Tenant.					INHABITANTS.				Roof, if in good repair.	Spouts, if in good repair.	VENTILATION OF BLOCKS.		STATE OF ROOMS.					WASTE PIPES.					
				Tenants with Common Entrance.			Flats or Self-contained.	Other-wise.	Family.		Lodgers.				Back Windows and Doors (W. D.)	Front Windows and Doors (W. D.)	If Dark, and from what cause?	If Damp, and from what cause?	Dilapidated.	Ceiling low, height from floor.	"Well" Rooms.	Ventilation otherwise defective, and how.	Clean.	Sinks and Stack-pipes, etc., if disconnected.	Bath, if disconnected.	Lavatory, etc., if disconnected.	Cistern, if disconnected.
				1 Room.	2 Rooms.	3 Rooms.	No. of Rooms.	No. of Rooms.	Under 12.	Over 12.	Under 12.	Over 12.			16	17	18	19	20	21	22	23	24	25	26	27	28
1	2	3	4	5	6	7	8	9	10	11	12	13	14	15	16	17	18	19	20	21	22	23	24	25	26	27	28

